



Carrier improves the world around us; Carrier improves people's lives; our products and services improve building performance; our culture of improvement will not allow us to rest when it comes to the environment.



AEROEDGE™

39CQ

Air-handling Unit

Air Flow : 2,000-100,000m³/h



www.carrier.com.hk

The Manufacturer reserves the right to change any product specifications without prior notices
© All Rights Reserved Carrier

Version:	CAT_39CQ_E-1403_01
Supersede:	-
Effective date:	Mar. 2014



Carrier China

Carrier Corporation is a subsidiary of the United Technologies Corp. (UTC), which ranks the 150th in Fortune Top 500 in 2011 and has its operations in aerospace and building systems industries all over the world. From the time the founder Dr. Carrier invented the first system of modern air conditioning in 1902, Carrier has been the world leader in the air conditioning industry with its products and system solutions supplied to numerous famous buildings, and up to now, the network of distribution cover more than 170 countries all over the world. In 2011, Carrier ranked top in the HVAC industry field with its sales revenue of US \$12 billion.

In China, there are 6 Carrier factories which have more than 2500 employees. As the world-class factory, Carrier has a number of technically advanced production lines, manufacturing commercial and residential chillers, compressors and air-side products. A wide range of products are able to meet diversified requirements of different customers. The global R&D center located in Shanghai has the capability of developing several major projects in the same time, with many advanced technical patents awarded to support Carrier stay most competitive in terms of technology advantage in the HVAC industry.

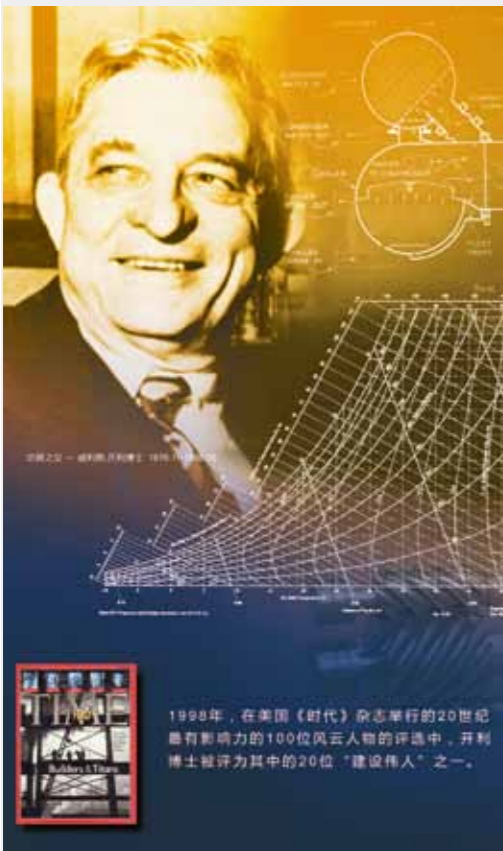

Identification & Dimension

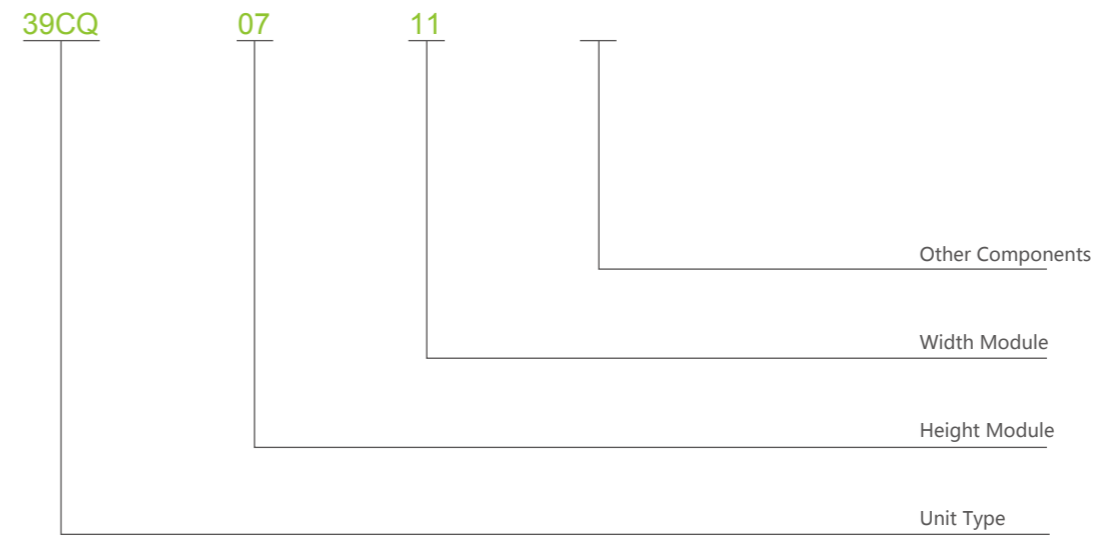

General rule of the height, width and length of a section or unit can be determined with the module concept:

A. 39CQ 0608~2333

(1) Unit Height = Height Module×100+90+100(base)

(2) Unit Width = Width Module×100+90

Example : 39CQ 0711

07 Height Module

Unit Height: $7 \times 100 + 90 + 100$ (base) = 890mm

11 Width Module

Unit Width: $11 \times 100 + 90 = 1190$ mm

B. 39CQ 2532~3438

31 Height Module

Unit Height: $31 \times 100 + 90 + 200$ (base) = 3390mm

32 Width Module

Unit Module: $32 \times 100 + 90 = 3290$ mm

Unit orientation

Unit Orientation is determined by the location of the inlet and outlet pipes of the coil and the access panel while facing unit in the direction of air flow.

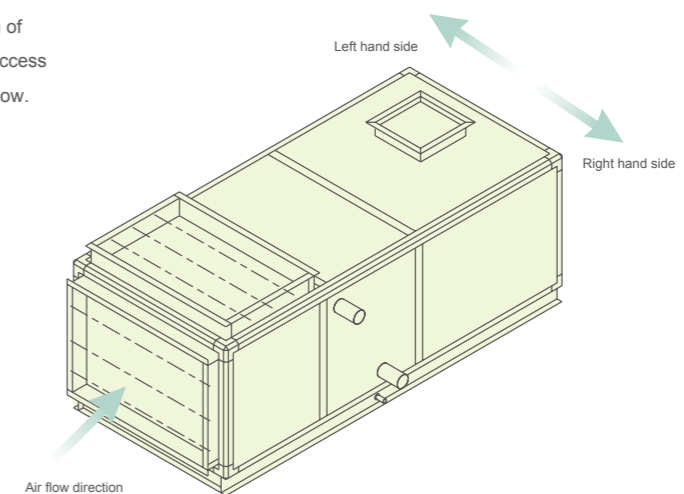

Air volume

39CQ

2,000-100,000m³/h

Superior casing performance T2/TB2/L2 (EN1886 standard)

Excellent airtightness

The casing is made up of panels, frame and sealing strips. New casing structure of the unit avoids that any of the interior support member is exposed and ensures smooth internal surface, easy for cleaning and maintenance. New type of sealing strips between the frame and the panels, and careful sealing design to all access panels and locations passing-through pipes ensure excellent air tightness of the units

Thermal bridge free

Carrier unique frame design enables pentapost and interpost covered by panel to prevent exposing in treated air, so the thermal bridge at posts is avoided. Each junction is subjected to special heat insulation treatment to prevent the thermal bridge effect. New design of screw also prevents the occurring of thermal bridge at screws, contributes to better casing performance.

Optimal thermal insulation

The middle layer of the unit panels is a 50mm thick PU foam with light weight, good rigidity, and thermal conductivity. Moreover, special insulation treatment is conducted at the inner parts of the frame and the middle frame strips to eliminate thermal transmission through the casing.

Access and serviceability design

Integrated control system

Factory assemble integrated control system with touch screen displayer saves installation and maintenance cost and ensures optimal operation.

Modular design convenient to select

The width, height and length of the unit are proportionally increased with 100mm as module. Each air volume corresponds with a certain unit type. Standard modular products make modeling and manufacturing faster and more convenient.

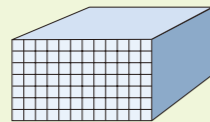

Double skin panel construction

High durability HDP painted panel as standard configuration of external panel ensures good rust preventive performance Galvanized steel is standard for interior panel, and stainless steel sheet is also available.

Unit base

Each section has a base, which enhances the strength of the whole unit, reduces vibration, and make it easy to transport and assemble.



Easy maintenance

All basic component parts are standard and interchangeable with competitive prices. The unit is designed to have removable panels on its one side, and the access panels are arranged in the necessary components, providing convenience for repair and maintenance of the fan, coil and filter. The coil is installed on the guide rail inside the drain pan, enabling easy maintenance, cleaning and removal.

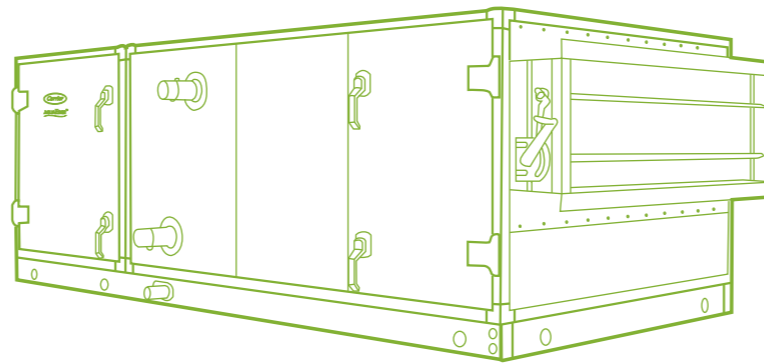

High quality IAQ

Various filters available to meet different needs

A complete line of filters is available, the levels of filters are ranging from primary filters (Panel type, filter class up to G4), to medium filters (Bag type, filter class up to F9), and to high filters (filter class up to H13). Some special filters such as activated-carbon filters, cartridge filters and electronstatic filters can also be provided.

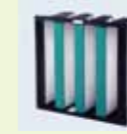

High efficiency filter



Bag filter



Panel filter

Flexible application

Optimized design, high efficiency and vibration-free operation

The fan impeller and pulley are statically and dynamically balanced, and the whole fan is calibrated through the operational vibration testing, making the fan to operate stably and smoothly. With the fan and motor assembly mounted on a common base with shock absorber and the fan outlet isolated from the casing by a flexible connection and completely separated from moving parts, the vibration is effectively isolated. Moreover, the forward or backward impeller may be selected according to the air pressure and volume.

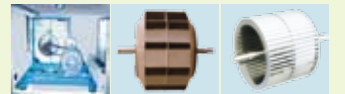

Hot and cold water coils designed according to international standard

Fins are the "dual sine-wave" form and mechanically bonded with copper tubes, realizing excellent heat transfer efficiency. Hydrophilic aluminum foils may also be utilized to achieve better heat transfer performance. The standard coil header is constructed of steel and can also be customized with lopper.



Headers have drain and vent connections, so coil is drainable and has non air trapping circuits. The water in the coil must be discharged in winter to avoid the frost crack of the coil.

If the coil face air velocity is higher than 2.5m/s, a drift eliminator can be installed on the back of the coil to effectively isolate moisture in air.

Corrugated damper flexible to adjust

With manual or electric mode available, the corrugated linkage damper can be opened flexibly, and can also add an electric controller as required.

Various heat recovery options

To improve indoor air quality is generally accomplished by introducing ventilation from outdoors. The air must be conditioned to match the indoor space. Carrier energy saving solution offer options for energy-recovery wheels, air-to-air heat exchangers, heat pipes, or coil-run-around loops. These proven technologies economically transfer energy between the exhaust-air and fresh-air paths, reducing the cost of conditioning the fresh air.



Heat wheels



Heat plate

Efficient and durable PM2.5 solution

Related researches show that indoor and outdoor pollutants are the most important contributory factor of diseases related to the environment. Air contaminants: particles, sulphur dioxide, ozone and nitrogen dioxide have serious effects on health particles, especially for particles below 2.5µm. Clear connection between increased pollution levels with particles below 2.5µm and increased mortality caused by cardiovascular and respiratory illness.

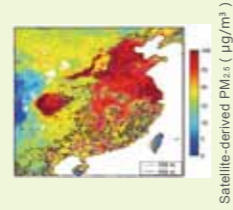

Carrier new efficient and durable PM2.5 filter using the latest nano filtration media, responds to criteria of new EN779 standard (F7 – F9 range), high efficiently filter out PM2.5 and other air pollutants, providing you with a clean and healthy indoor environment.

Efficient and stable filtration performance, PM2.5 removal efficiency up to 98.5% *

Carrier PM2.5 filter using the latest nano filtration media, purely mechanical filtration principle, Media is not charged – no charge dissipation and media performance remains intact for PM 2.5 µm particles. Common synthetic filter with electrostatic charged media, static electricity continue to disappear during use, filtration efficiency will drop sharply, so it need to be replaced frequently.*

*Includes all particle of 0.1~2.5µm diameter

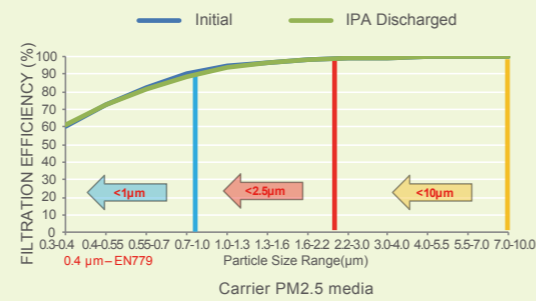
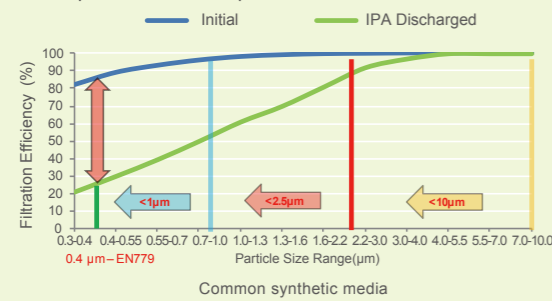

More than double the dust load capacity – longer life

Combining fine fiber and filtration surface, fine fiber with greatly increased surface area and double the dust load capacity in the media. Compared with normal synthesis filter, PM2.5 filter has longer lifetime, reducing the routine maintenance costs.



Lower energy consumption, superior energy classification according to Eurovent 4/11

Under the same efficiency level, the initial pressure drop of Carrier new PM2.5 filter is 35% lower than that of glass mat. Lower pressure drop, lower energy consumption.

Filter dustloading(g)vs.Pressure drop(Pa)

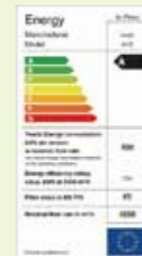
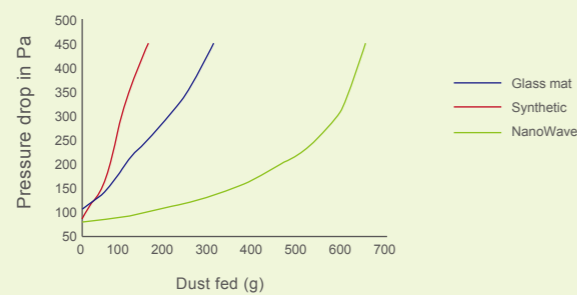

Integrated control system

39CQ air handling units, optional Carrier integrated control system, this new control system adopts advanced control and management system, and its control scheme can be optimized for different application requirements. Touch screen graphical display, more user friendly. Factory-mounted integrated controls saves installation and maintenance cost and ensures optimal operation

Major control functions

- The unit is available with both stand-alone control or network control (can support BACnet Protocol)
- Standard control system includes the following functions:
 - Variable air flow control (standard with inverter)
 - CO2 demand control
 - Supply air temperature control by adjusting water valve
 - Humidifier On/Off control in winter
 - Filter alarm
 - Fan and outside air damper interlocking
- User-friendly control interface makes field commissioning and operation easy.
- AHU controller, temperature/humidity sensors, CO2 sensor and pressure sensor are factory

- mounted, which prevents possible damage during field installation.
- Major control component include:
 - SE6104 controller and auxiliary board
 - BACview6 control panel
 - Return air and outside air temperature sensors
 - Supplier air temperature and humidity sensors
 - CO2 sensor
 - Filter differential pressure switch
 - Inverter
 - Motorized proportional control valves
 - Motorized proportional control dampers
 - Options: anti-freeze switch, static pressure sensor, indoor temperature and humidity sensor.



Control diagram

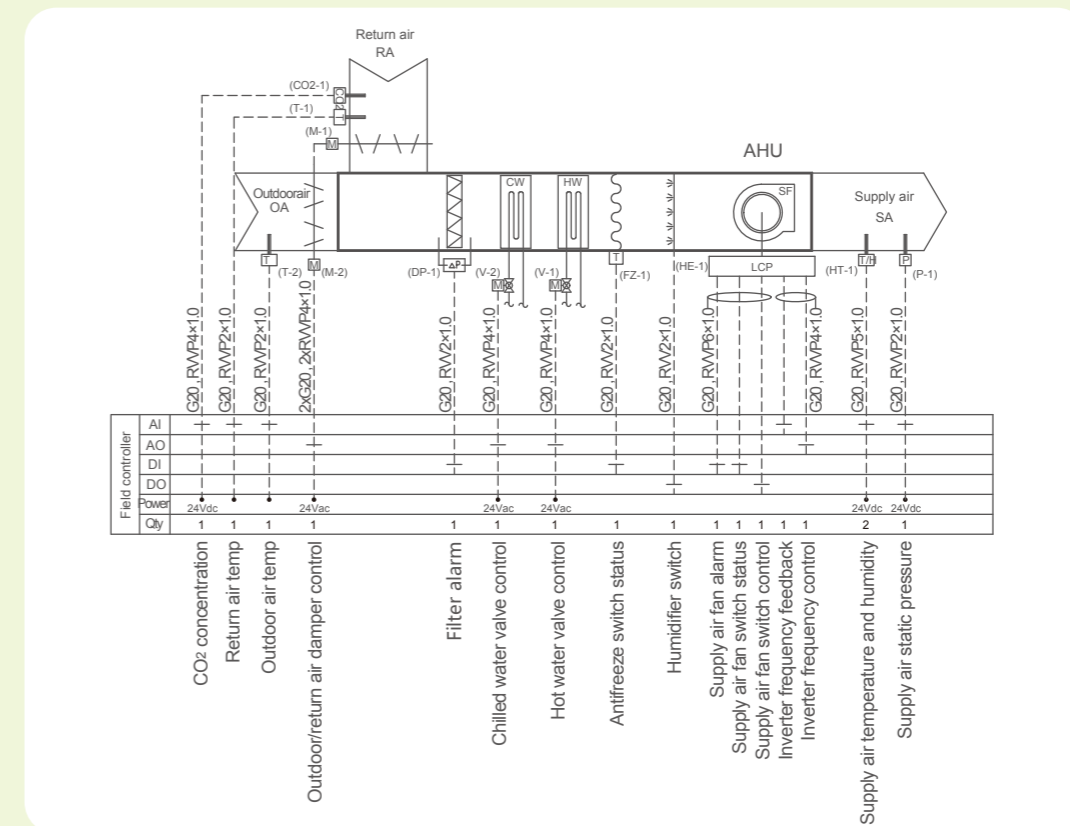

Quick selection

Model	Coil Face	Air Volume (m³/h)			Inside Dimension of Damper (mm*mm)	Dimensions(mm)	
		Face Velocity				Hight	Width
	Aera (m²)	2.25 m/s	2.5 m/s	2.75 m/s			
39CQ0608	0.23	1863	2070	2277	756*322.5	690	890
39CQ0609	0.32	2592	2880	3168	856*322.5	690	990
39CQ0711	0.46	3726	4140	4554	1056*322.5	790	1190
39CQ0811	0.57	4617	5130	5643	1056*322.5	890	1190
39CQ0912	0.69	5589	6210	6831	1156*322.5	990	1290
39CQ0913	0.76	6156	6840	7524	1256*480	990	1390
39CQ0914	0.84	6804	7560	8316	1356*480	990	1490
39CQ1015	1.06	8586	9540	10494	1456*480	1090	1590
39CQ1117	1.31	10611	11790	12969	1656*480	1190	1790
39CQ1317	1.68	13608	15120	16632	1656*480	1390	1790
39CQ1418	1.90	15390	17100	18810	1756*637.5	1490	1890
39CQ1420	2.14	17334	19260	21186	1956*637.5	1490	2090
39CQ1621	2.62	21222	23580	25938	2056*637.5	1690	2190
39CQ1822	3.26	26406	29340	32274	2156*795	1890	2290
39CQ1825	3.75	30375	33750	37125	2456*795	1890	2590
39CQ2025	4.04	32724	36360	39996	2456*795	2090	2590
39CQ2125	4.33	35073	38970	42867	2456*952.5	2190	2590
39CQ2226	4.82	39042	43380	47718	2556*952.5	2290	2690
39CQ2328	5.39	43659	48510	53361	2756*952.5	2390	2890
39CQ2330	5.81	47061	52290	57519	2956*952.5	2390	3390
39CQ2333	6.44	52164	57960	63756	3256*952.5	2390	3390
39CQ2532	8.06	65286	72540	79794	3156*952.5	2590	3290
39CQ2832	8.97	72657	80730	88803	3156*952.5	2890	3290
39CQ3132	9.89	80109	89010	97911	3156*1267.5	3190	3290
39CQ3438	12.16	98496	109440	120384	3756*1267.5	3490	3890

Notes: 1. The unit height does not include the damper on the top and the base of 100mm(0608-2333)/200mm(2532-3438)
2. Above table is just for your reference. Please refer Carrier AHU selection software for detail information.

Computer selection

Our company provides the double-quick and accurate computer selection. We will get the reasonable and economic unit by working out the optimal function configuration to meet the customer's requirement.

Functions & features

- Project Management
- Modular Designer
- Free Section Combining
- Section & Option Configuration
- Shipping Configuration
- Performance Calculation
- Quotation
- Drawings & Tech Specification
- Multilingual & Friendly Interface



















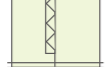

Electric heater selection















No.	Unit Model		Face Area (m²)	1 Row Heater	2 Row Heater	3 Row Heater
	Unit Size	Max. Capacity of Single Pipe(W)		Power range(kW)	Power range(kW)	Power range(kW)
1	39CQ0608	690	0.21	<5	5~10	10~15
2	39CQ0609	840	0.25	<6	6~12	10~18
3	39CQ0711	1140	0.34	<8	8~16	16~24
4	39CQ0811	1140	0.49	<12	12~24	24~36
5	39CQ0912	1290	0.65	<14	14~28	28~42
6	39CQ0913	1440	0.72	<16	16~32	32~48
7	39CQ0914	1590	0.80	<18	18~36	36~54
8	39CQ1015	1740	0.99	<26	26~52	52~78
9	39CQ1117	2040	1.29	<30	30~60	60~90
10	39CQ1317	2040	1.56	<35	35~70	70~105
11	39CQ1418	2200	1.83	<40	40~80	80~120
12	39CQ1420	2500	2.08	<45	45~90	90~135
13	39CQ1621	2650	2.55	<48	48~96	96~144
14	39CQ1822	2800	3.07	<60	60~120	120~180
15	39CQ1825	3250	3.56	<70	70~140	140~210
16	39CQ2025	3250	4.00	<85	85~170	170~255
17	39CQ2125	3250	4.21	<90	90~180	180~270
18	39CQ2226	3400	4.63	<95	95~190	190~285
19	39CQ2328	3700	5.29	<105	105~210	210~315
20	39CQ2330	4160	5.74	<114	100~225	200~335
21	39CQ2333	4450	6.36	<125	125~250	250~375
22	39CQ2532	5380	6.33	<145	145~290	290~435
23	39CQ2832	5380	7.24	<160	160~320	320~480
24	39CQ3132	5380	8.15	<175	175~350	350~525
25	39CQ3438	6250	10.56	<225	225~450	450~675

Note : 1. Star connection is used in the wiring of electric heaters. Multi-group control is available, in which the capacity for each group is generally 30kW or less.
The power supply is 3-phase 380V.
2. Minimum air velocity is 2m/s.
3. 3M module holds maximum of 3 row heater.
4. Capacity exceeding 3 row should choose two separated heaters in 6M module section.

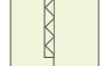
Standard components (0608~2333)

No.	Unit Section	Diagram	Section Length (M: Module)	Remark
1	Return/Mixing Chamber		(0608~0912) 5M (0913~1317) 6M (1418~1621) 8M (1822~2025) 9M (2125~2333) 11M	
2	Bag Filter		6M	Access section is recommended at upstream
3	Combined Filter		6M	Access section is recommended at upstream
4	Cooling Coil		5M or 6M	The section length is 5M with drift eliminator and 6M without drift eliminator
5	Heating Coil		3M	May be installed together with the cooling coil if this cooling coil does not include a film humidifier and a drift eliminator
6	Steam Heating Coil		3M	
7	Electric Heating Coil		3M	
8	Steam Humidifier		6M	
9	Film Humidifier		3M	May be installed directly in the coils and drain pan, no additional space needed
10	Spray Humidifier		6M	Could share the drift eliminator with cooling coil when it is installed next the coil.
11	Fan		Refer to fan table	Four discharge configurations available
12	Combined Mixing Chamber		(0608~0913) 10M (0914~1825) 12M (2025~2333) 18M	
13	Attenuator		6M(1 Level) 12M(2 Level)	Access section is recommended at upstream
14	Supply Chamber		(0608~0912) 5M (0913~1317) 6M (1418~1621) 8M (1822~2025) 9M (2125~2333) 11M	Supply damper may be installed in either a vertical or a horizontal position
15	Plenum/Access		3M, 6M	
16	High Efficiency Filter		9M	
17	Energy Recovery		6M	
18	Electric Humidifier		6M	
19	Electrostatic Filter		6M	

Standard components (2532~3438)

No.	Unit Section	Diagram	Section Length (M: Module)	Remark
1	Return/Mixing Chamber		(2532~2832) 12M (3132~3438) 15M	
2	Bag Filter		6M	Access section is recommended at upstream
3	Combined Filter		6M	Access section is recommended at upstream
4	Cooling Coil		12M	
5	Heating Coil		3M	
6	Steam Heating Coil		3M	
7	Electric Heating Coil		3M	
8	Steam Humidifier		6M	
9	Fan		Refer to fan table	Four discharge configurations available
10	Combined Mixing Chamber		(2532~2832) 12M (3132~3438) 15M	
11	Attenuator		6M(1 Level) 12M(2 Level)	Access section is recommended at upstream
12	Supply Chamber		(2532~2832) 12M (3132~3438) 15M	Supply damper may be installed in either a vertical or a horizontal position
13	Plenum/Access		3M, 6M	
14	High Efficiency Filter		9M	
15	Electric Humidifier			
16	Electrostatic Filter		6M	

1/2" Coil connection(0608~2333)

Cooling coil 0608~1825

Unit Size	A	B	F	D						E						ØC
				3R	4R	5R	6R	7R	8R	3R	4R	5R	6R	7R	8R	
0608	800	357	232	105	91	77	63	102	84	160	174	187	201	212	226	1-1/2" MPT
0609	800	421	232	105	91	77	63	102	84	160	174	187	201	212	226	1-1/2" MPT
0711	900	472	238	105	91	77	70	102	84	175	174	187	194	212	226	2" MPT
0811	1000	599	238	105	91	77	70	102	84	175	174	187	194	212	226	2" MPT
0912	1100	648	246	105	91	77	77	102	84	187	174	187	187	212	226	2-1/2" MPT
0913	1100	648	246	105	91	77	77	102	84	187	174	187	187	212	226	2-1/2" MPT
0914	1100	648	246	105	91	77	77	102	84	187	174	187	187	212	226	2-1/2" MPT
1015	1200	775	246	105	91	77	77	102	84	187	174	187	187	212	226	2-1/2" MPT
1117	1300	824	253	84	84	84	84	102	84	180	181	180	180	212	226	3" MPT
1317	1500	1078	253	84	84	84	84	102	84	180	181	180	180	212	226	3" MPT
1418	1600	1142	253	84	84	84	84	102	84	180	181	180	180	212	226	3" MPT
1420	1600	1142	253	84	84	84	84	102	84	180	181	180	180	212	226	3" MPT
1621	1800	1332	253	84	84	84	84	102	84	180	181	180	180	212	226	3" MPT
1822	2000	1586	253	84	84	84	84	102	84	180	181	180	180	212	226	3" MPT
1825	2000	1586	253	84	84	84	84	102	84	180	181	180	180	212	226	3" MPT

Heating coil 0608~1825

Unit Size	A	F	D		B		E		ØC
			1R	2R	1R	2R	1R	2R	
0608	800	232	62	61.75	341	357	131	131	1-1/2" MPT
0609	800	232	62	61.75	405	421	131	131	
0711	900	232	62	61.75	468	484	131	131	
0811	1000	232	62	61.75	595	611	131	131	
0912	1100	232	62	61.75	659	675	131	131	
0913	1100	232	62	61.75	659	675	131	131	
0914	1100	232	62	61.75	659	675	131	131	
1015	1200	232	62	61.75	786	802	131	131	
1117	1300	232	62	61.75	849	865	131	131	
1317	1500	232	62	61.75	1103	1119	131	131	
1418	1600	232	62	61.75	1167	1183	131	131	
1420	1600	232	62	61.75	1167	1183	131	131	
1621	1800	232	62	61.75	1357	1373	131	131	
1822	2000	232	62	61.75	1611	1627	131	131	
1825	2000	232	62	61.75	1611	1627	131	131	

Note: The data in table are just for your reference

Cooling coil 2025~2333

Unit Size	A	B	F	G	D			E				ØC	
					3R/4R/6R	5R	7R	8R	3R/4R/6R	5R	7R		8R
2025	2200	950	257	694	109	84	102	88	206	230	212	226	3" MPT
2125	2300	1077	257	694	109	84	102	88	206	230	212	226	3" MPT
2226	2400	1204	257	694	109	84	102	88	206	230	212	226	3" MPT
2328	2500	1268	257	694	109	84	102	88	206	230	212	226	3" MPT
2333	2500	1268	257	694	109	84	102	88	206	230	212	226	3" MPT

Heating coil 2025~2333

Unit Size	A	F	B		D		E		G		H		ØC
			1R	2R	1R	2R	1R	2R	1R	2R			
2025	2200	232	976	992	62	61.75	131	131	723	729	62	56	1-1/2" MPT
2125	2300	232	1103	1119	62	61.75	131	131	723	729	62	56	
2226	2400	232	1230	1246	62	61.75	131	131	723	729	62	56	
2328	2500	232	1294	1309.5	62	61.75	131	131	723	729	62	56	
2333	2500	232	1294	1309.5	62	61.75	131	131	723	729	62	56	

Note: The data in table are just for your reference

3/8" Coil connection(0608~1317)

3/8" Cooling & Heating coil dimension

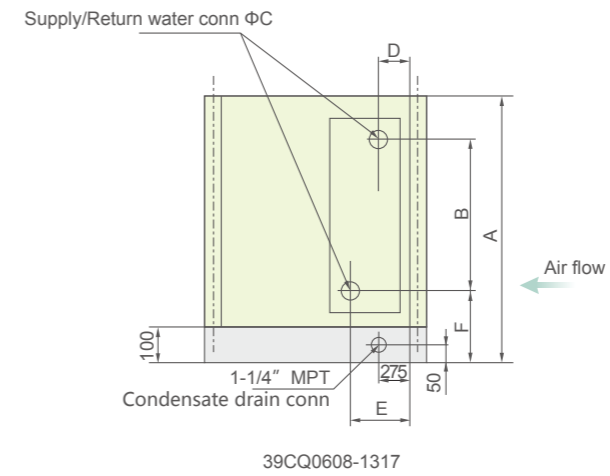

Cooling coil 0608~1317

Unit Size	A	F	B	D					E					ØC
				3R	4R/6R	5R	7R	8R	3R	4R/6R	5R	7R	8R	
0608	800	231	384	95	77	88	91	102	169	187	176	223	212	1-1/2" MPT
0609	800	231	435	95	77	88	91	102	169	187	176	223	212	1-1/2" MPT
0711	900	237	474	95	77	88	91	102	169	187	176	223	212	2" MPT
0811	1000	237	576	95	77	88	91	102	169	187	176	223	212	2" MPT
0912	1100	245	661	85	77	88	91	102	179	187	176	223	212	2-1/2" MPT
0913	1100	245	661	85	77	88	91	102	179	187	176	223	212	2-1/2" MPT
0914	1100	245	661	85	77	88	91	102	179	187	176	223	212	2-1/2" MPT
1015	1200	245	763	85	77	88	91	102	179	187	176	223	212	2-1/2" MPT
1117	1300	252	850	85	84	88	91	102	179	180	176	223	212	3" MPT
1317	1500	252	1054	85	84	88	91	102	179	180	176	223	212	3" MPT

Note: The data in table are just for your reference

Heating coil 0608~1317

Unit Size	A	F	B		D	E	ØC
			1R	2R	1R/2R	1R/2R	
0608	800	231	372	385	62	131	1-1/2" MPT
0609	800	231	423	436	62	131	
0711	900	231	474	487	62	131	
0811	1000	231	575	588	62	131	
0912	1100	231	677	690	62	131	
0913	1100	231	677	690	62	131	
0914	1100	231	677	690	62	131	
1015	1200	231	778	791	62	131	
1117	1300	231	880	893	62	131	
1317	1500	231	1083	1096	62	131	

Note: The data in table are just for your reference

1/2" Cooling & heating coil dimension

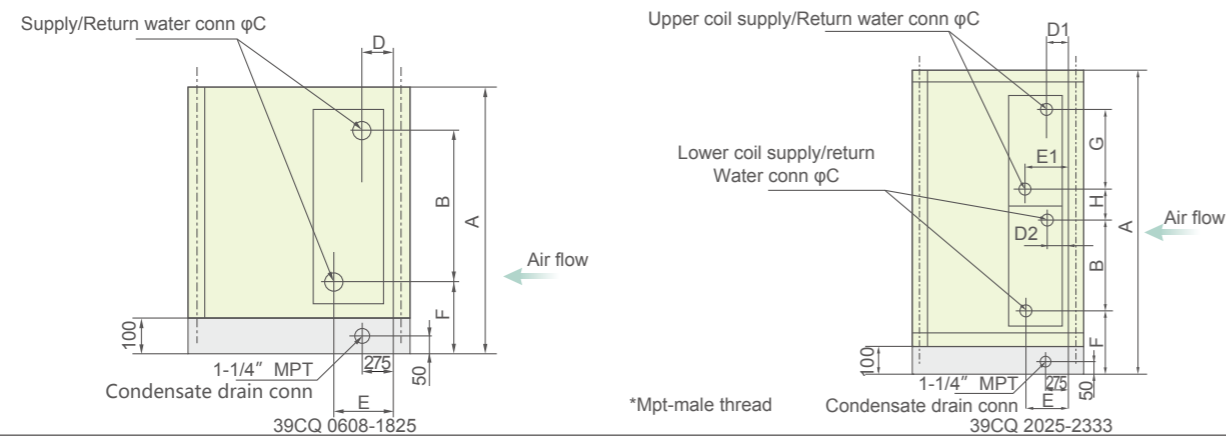

Cooling coil connection(2532~3438)

Unit Size	Total Qty of Coil	Coil Model*Qty	Coil Diameter*Qty
39CQ 2532	2	5100*2	Ø89*4
39CQ 2832	2	5100*1	Ø89*2
		6100*1	6100 upper coil: Ø48*2 6100 upper coil: Ø89*2
39CQ 3132	2	5100*1	Ø89*2
		7100*1	7100 upper coil: Ø48*2 7100 upper coil: Ø89*2
39CQ 3438	4	760*2	760 upper coil: Ø48*4 760 upper coil: Ø89*4
		660*2	660 upper coil: Ø48*4 660 upper coil: Ø60*4

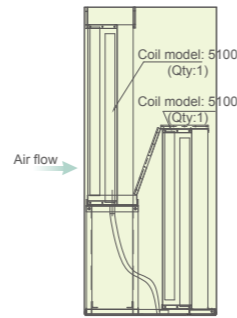

Figure 1:39CQ 2532

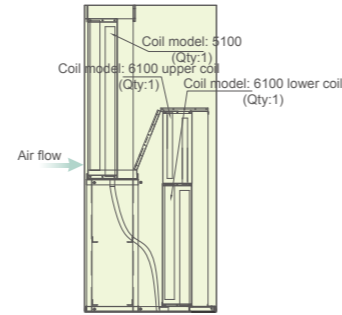

Figure 2:39CQ 2832

Note: The data in table are just for your reference

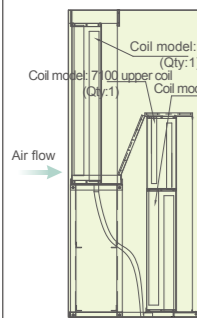

Figure 3:39CQ 3132

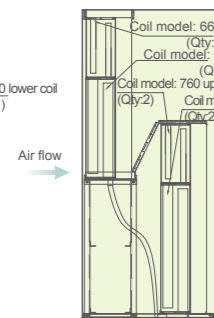

Figure 4:39CQ 3438

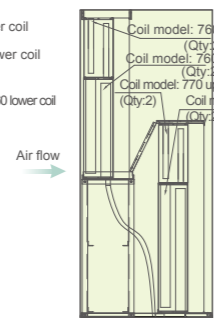

Figure 5:39CQ 3841

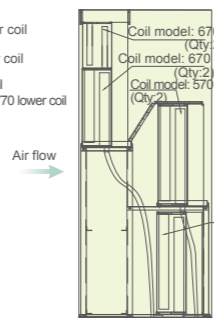

Figure 6:39CQ 4444

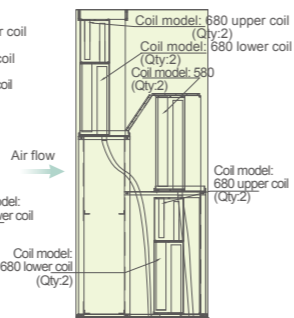

Figure 7:39CQ 4750

Heating coil connection(2532~3438)

Unit Size	Total Qty of Coil	Coil Model*Qty	Coil Diameter*Qty
39CQ 2532	2	4100*2	Ø48*4
39CQ 2832	2	4100*1	Ø48*2
		5100*1	Ø48*2
39CQ 3132	2	5100*2	Ø48*4
39CQ 3438	6	360*2	Ø48*4
		460*4	Ø48*8

Note: The data in table are just for your reference

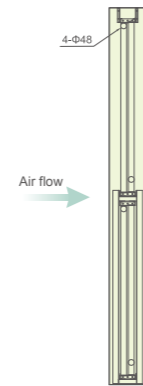

Figure 1:39CQ 2532,2832, 3132

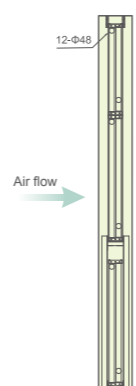
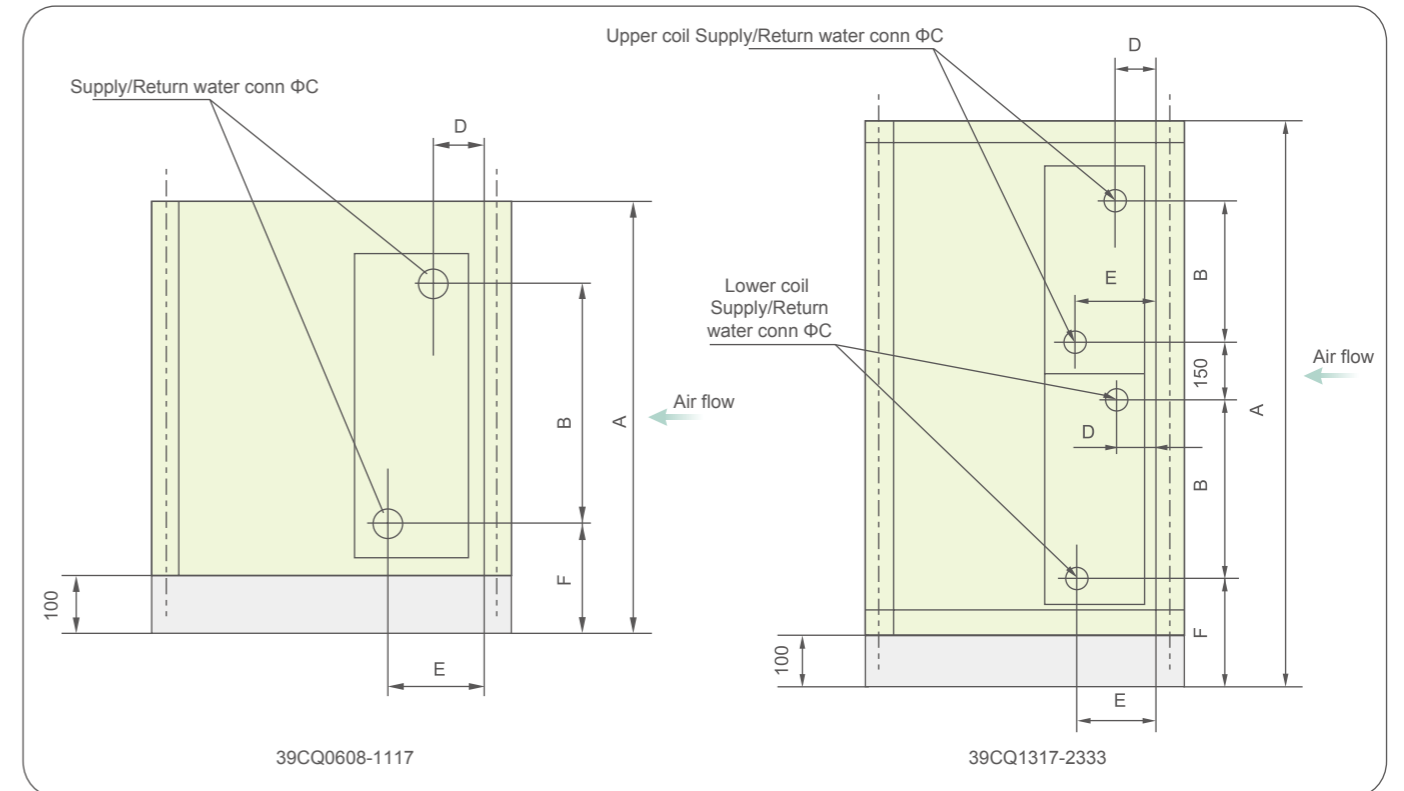
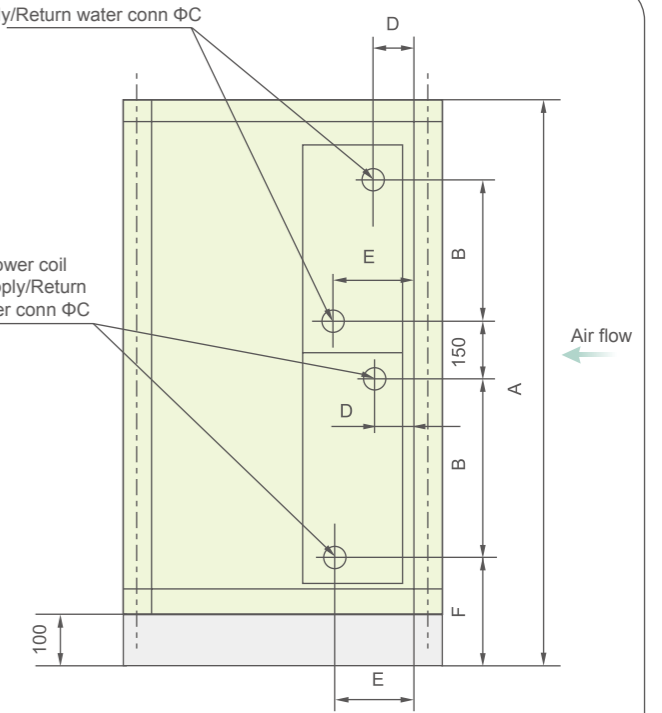

Figure 2:39CQ 3438,3841,4444,4750

Steam coil connection(0608~2333)



39CQ0608-1117



39CQ1317-2333

Unit Size	A	F	B	ØC	D	E
0608	790	243	347	2" MPT	80	150
0609	790	243	347	2" MPT	80	150
0711	890	243	418	2" MPT	80	150
0811	990	243	560	2" MPT	80	150
0912	1090	243	631	2" MPT	80	150
0913	1090	243	631	2" MPT	80	150
0914	1090	243	631	2" MPT	80	150
1015	1190	243	738	2" MPT	80	150
1117	1290	243	738	2" MPT	80	150

Note: The data in table are just for your reference

Unit Size	A	F	B	ØC	D	E
1317	1490	243	489	2" MPT	80	150
1418	1590	243	520	2" MPT	80	150
1420	1590	243	520	2" MPT	80	150
1621	1790	243	631	2" MPT	80	150
1822	1990	243	738	2" MPT	80	150
1825	1990	243	738	2" MPT	80	150
2025	2190	243	844	2" MPT	80	150
2125	2290	243	844	2" MPT	80	150
2226	2390	243	844	2" MPT	80	150
2328	2490	243	884	2" MPT	80	150
2330	2490	243	884	2" MPT	80	150
2333	2490	243	884	2" MPT	80	150

Note: The data in table are just for your reference. Connection dimensions of unit 2532 and above depend on the actual condition.

Fan & Motor (0608~2333)

Unit Size	Fan Model	Max.Motor Power (kW)	Max.Motor Model	Fan Section Length	
				Horizontal (mm)	Vertical (mm)
39CQ0608	ADZ160	1.5	Y90	600	900
	ADZ180			600	900
39CQ0609	ADZ180	2.2	Y100	600	900
	ADZ200			700	900
39CQ0711	ADZ200	3.7	Y112	700	900
	ADZ225			700	900
39CQ0811	ADZ225	3.7	Y112	700	900
	ADZ/RDZ250			700	900
39CQ0912	ADZ/RDZ250	5.5	Y132	700	900
	ADZ/RDZ280			800	900
39CQ0913	ADZ/RDZ280	5.5	Y132	800	900
	ADZ/RDZ315			800	900
39CQ0914	ADZ/RDZ315	7.5	Y132	800	900
	ADZ/RDZ355			900	900
39CQ1015	ADZ/RDZ355	7.5	Y132	900	900
	ADZ/RDZ400			900	900
39CQ1117	ADZ/RDZ400	11	Y160	900	900
	ADZ/RDZ450			1100	1100
39CQ1317	ADZ/RDZ400	15	Y160	900	900
	ADZ/RDZ450			1100	1100
39CQ1418	ADZ/RDZ450	15	Y160	1100	1100
	ADZ/RDZ500			1100	1100
39CQ1420	ADZ/RDZ500	18.5	Y180	1100	1100
	ADZ/RDZ560			1300	1300
39CQ1621	ADZ/RDZ560	18.5	Y180	1300	1300
	ADZ/RDZ630			1400	1400
39CQ1822	ADZ/RDZ560	18.5	Y180	1300	1300
	ADZ/RDZ630			1400	1400
39CQ1825	ADZ/RDZ630	30	Y200	1400	1400
	ADZ/RDZ710			1500	1500
39CQ2025	ADZ/RDZ630	30	Y200	1400	1400
	ADZ/RDZ710			1500	1500
39CQ2125	ADZ/RDZ710	30	Y200	1500	1500
	ADZ/RDZ800			1700	1700
39CQ2226	ADZ/RDZ710	30	Y200	1500	1500
	ADZ/RDZ800			1700	1700
39CQ2328	ADZ/RDZ800	37	Y225	1700	1700
	ADZ/RDZ900			1900	1900
39CQ2330	ADZ/RDZ800	37	Y225	1700	1700
	ADZ/RDZ900			1900	1900
39CQ2333	ADZ/RDZ800	45	Y225	1700	1700
	ADZ/RDZ900			1900	1900

Note: The length mentioned is internal dimensions of fan section

Fan arrangement-horizontal unit

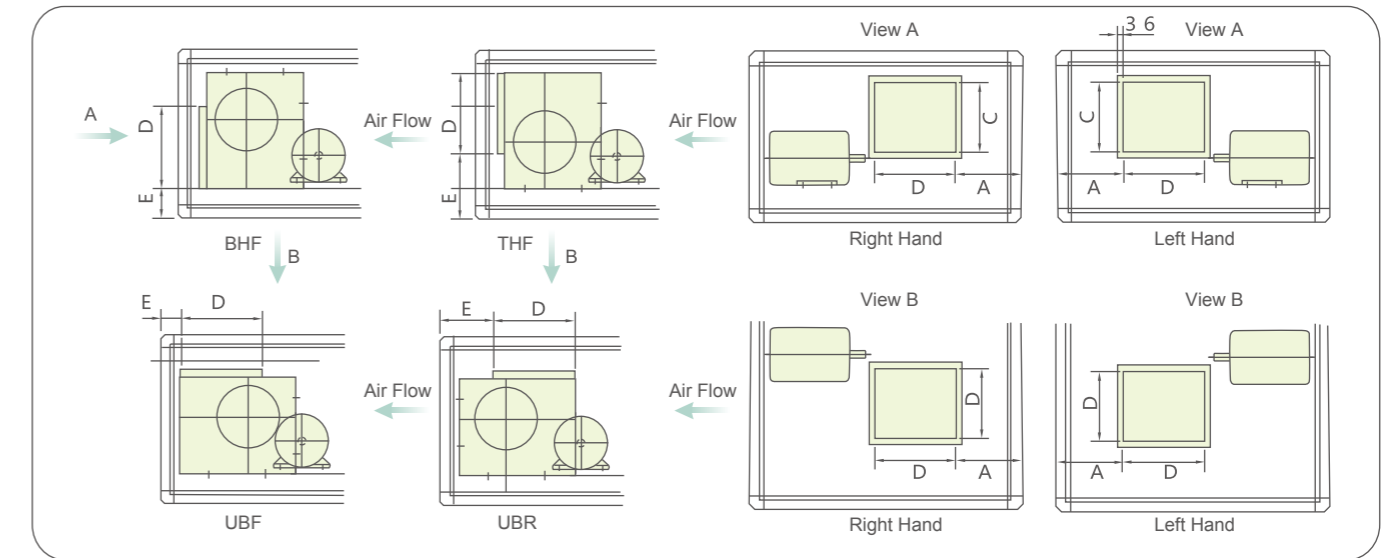

(mm)

Unit Size	Fan Model	A	D	E			
				THF	BHF	UBF	UBR
39CQ0608	ADZ160	224.0	205.0	285.5	163.0	170.0	192.0
	ADZ180	179.5	229.0	285.5	163.0	170.0	217.0
39CQ0609	ADZ180	291.0	229.0	285.5	163.0	170.0	217.0
	ADZ200	260.5	256.0	293.5	163.0	170.0	226.0
39CQ0711	ADZ200	360.5	256.0	293.5	163.0	170.0	226.0
	ADZ225	311.5	288.0	307.5	163.0	170.0	263.0
39CQ0811	ADZ225	311.5	288.0	307.5	163.0	170.0	263.0
	ADZ/RDZ250	311.5	322.0	319.0	163.0	170.0	252.0
39CQ0912	ADZ/RDZ250	361.5	322.0	319.0	163.0	170.0	252.0
	ADZ/RDZ280	335.5	361.0	336.0	163.0	170.0	301.0
39CQ0913	ADZ/RDZ280	385.5	361.0	336.0	163.0	170.0	301.0
	ADZ/RDZ315	342.5	404.0	355.0	163.0	170.0	288.0
39CQ0914	ADZ/RDZ315	392.5	404.0	355.0	163.0	170.0	288.0
	ADZ/RDZ355	395.5	453.0	380.0	188.0	170.0	310.0
39CQ1015	ADZ/RDZ355	445.5	453.0	380.0	188.0	170.0	310.0
	ADZ/RDZ400	394.5	507.0	408.0	188.0	170.0	340.0
39CQ1117	ADZ/RDZ400	494.5	507.0	408.0	188.0	170.0	340.0
	ADZ/RDZ450	434.5	569.0	437.0	188.0	170.0	368.0
39CQ1317	ADZ/RDZ400	494.5	507.0	408.0	188.0	170.0	340.0
	ADZ/RDZ450	389.5	569.0	437.0	188.0	170.0	368.0
39CQ1418	ADZ/RDZ450	439.5	569.0	437.0	188.0	170.0	368.0
	ADZ/RDZ500	420.5	638.0	458.0	188.0	170.0	390.0
39CQ1420	ADZ/RDZ500	520.5	638.0	458.0	188.0	170.0	390.0
	ADZ/RDZ560	511.5	715.0	549.0	248.0	170.0	421.0
39CQ1621	ADZ/RDZ560	511.5	715.0	549.0	248.0	170.0	421.0
	ADZ/RDZ630	425.5	801.0	591.0	248.0	170.0	464.0
39CQ1822	ADZ/RDZ560	611.5	715.0	549.0	248.0	170.0	421.0
	ADZ/RDZ630	525.5	801.0	591.0	248.0	170.0	464.0
39CQ1825	ADZ/RDZ630	720.5	801.0	591.0	248.0	170.0	464.0
	ADZ/RDZ710	623.5	898.0	639.0	248.0	170.0	511.0
39CQ2025	ADZ/RDZ630	720.5	801.0	591.0	248.0	170.0	464.0
	ADZ/RDZ710	623.5	898.0	639.0	248.0	170.0	511.0
39CQ2125	ADZ/RDZ710	573.5	898.0	639.0	248.0	170.0	511.0
	ADZ/RDZ800	513.5	1007.0	708.0	261.0	170.0	567.0
39CQ2226	ADZ/RDZ710	673.5	898.0	639.0	248.0	170.0	511.0
	ADZ/RDZ800	613.5	1007.0	708.0	261.0	170.0	567.0
39CQ2328	ADZ/RDZ800	663.5	1007.0	708.0	261.0	170.0	567.0
	ADZ/RDZ900	635.5	1130.0	765.0	261.0	170.0	624.0
39CQ2333	ADZ/RDZ800	815.0	1007.0	708.0	261.0	170.0	567.0
	ADZ/RDZ900	787.0	1130.0	765.0	261.0	170.0	624.0
39CQ2333	ADZ/RDZ800	963.5	1007.0	708.0	261.0	170.0	567.0
	ADZ/RDZ900	935.5	1130.0	765.0	261.0	170.0	624.0

Note: The length mentioned is internal dimensions of fan section

Fan arrangement-vertical unit

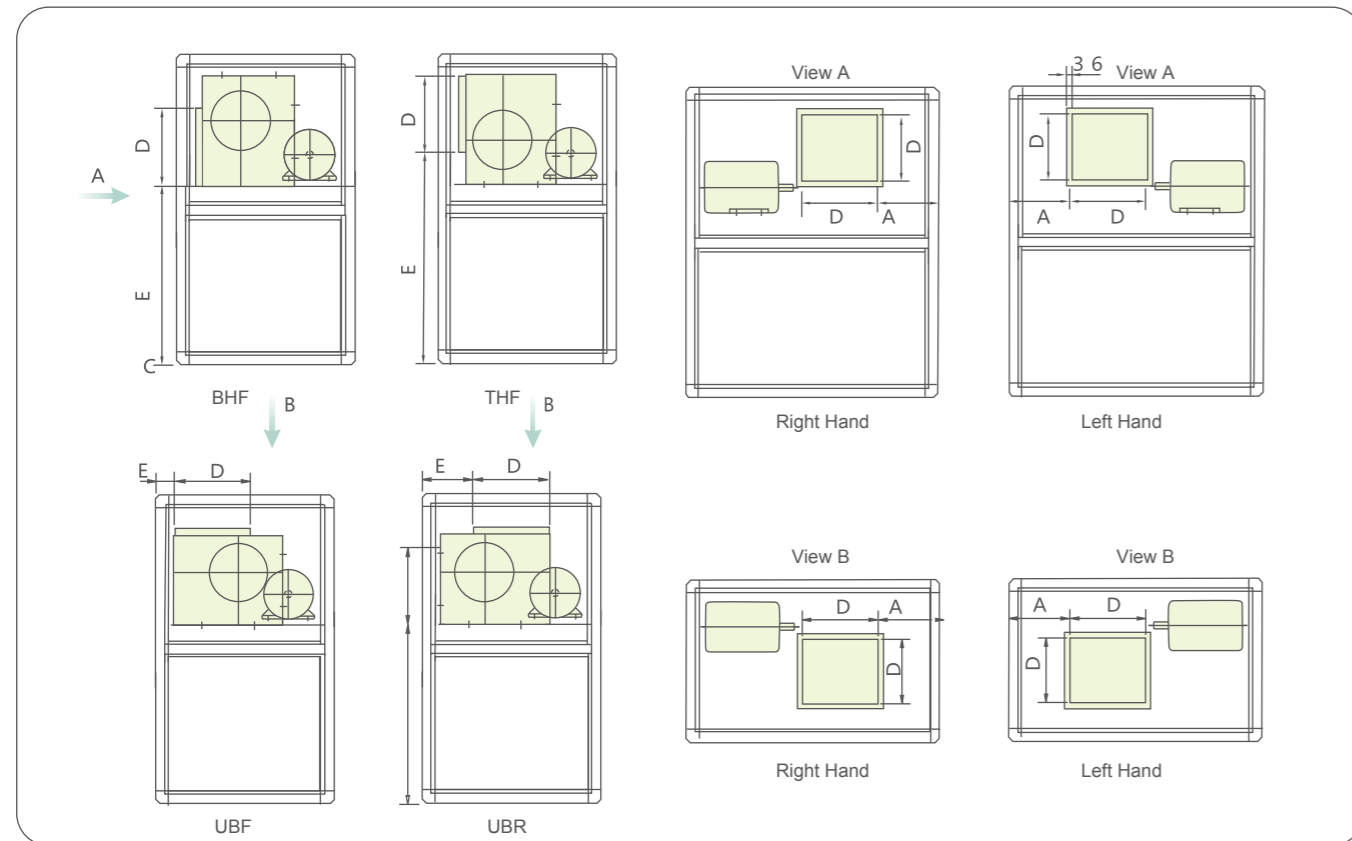

(mm)

Unit Size	Fan Model	A	D	E			
				THF	BHF	UBF	UBR
39CQ0608	ADZ160	224.0	205	985.5	863.0	170	192
	ADZ180	179.5	229	985.5	863.0	170	217
39CQ0609	ADZ180	291.0	229	985.5	863.0	170	217
	ADZ200	260.5	256	993.5	863.0	170	226
39CQ0711	ADZ200	360.5	256	1093.5	963.0	170	226
	ADZ225	311.5	288	1107.5	963.0	170	263
39CQ0811	ADZ225	311.5	288	1207.5	1063.0	170	263
	ADZ/RDZ250	311.5	322	1219.0	1063.0	170	252
39CQ0912	ADZ/RDZ250	361.5	322	1319.0	1163.0	170	252
	ADZ/RDZ280	335.5	361	1336.0	1163.0	170	301
39CQ0913	ADZ/RDZ280	385.5	361	1336.0	1163.0	170	301
	ADZ/RDZ315	342.5	404	1355.0	1163.0	170	288
39CQ0914	ADZ/RDZ315	392.5	404	1355.0	1163.0	170	288
	ADZ/RDZ355	395.5	453	1380.0	1188.0	170	310
39CQ1015	ADZ/RDZ355	445.5	453	1480.0	1288.0	170	310
	ADZ/RDZ400	394.5	507	1508.0	1288.0	170	340
39CQ1117	ADZ/RDZ400	494.5	507	1608.0	1388.0	170	340
	ADZ/RDZ450	434.5	569	1637.0	1388.0	170	368
39CQ1317	ADZ/RDZ400	494.5	507	1808.0	1588.0	170	340
	ADZ/RDZ450	389.5	569	1837.0	1588.0	170	368
39CQ1418	ADZ/RDZ450	439.5	569	1937.0	1688.0	170	368
	ADZ/RDZ500	420.5	638	1958.0	1688.0	170	390
39CQ1420	ADZ/RDZ500	520.5	638	1958.0	1688.0	170	390
	ADZ/RDZ560	511.5	715	2049.0	1748.0	170	421
39CQ1621	ADZ/RDZ560	511.5	715	2249.0	1948.0	170	421
	ADZ/RDZ630	425.5	801	2291.0	1948.0	170	464

Note: The data in table are just for your reference

Fan arrangement-horizontal unit (2532~3438)

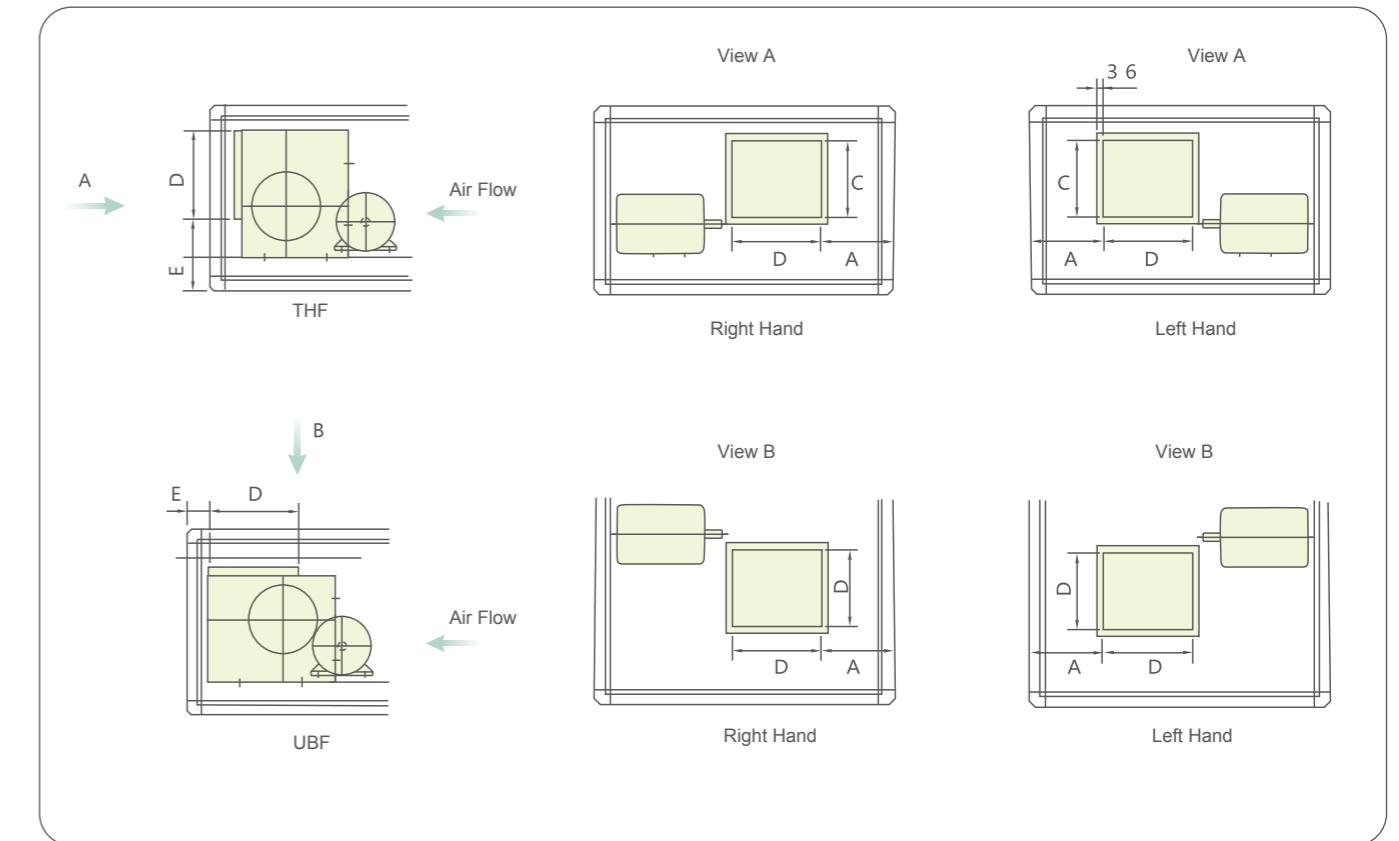

(mm)

Unit Size	Fan Model	A	D	E	
				THF	UBF
39CQ 2532	KHF900	935	1130	825	279
	KHF1000	783.5	1267	867.5	190
39CQ 2832	KHF1000	783.5	1267	867.5	190
	KHF1120	556	1422	978	195
39CQ 3132	KHF1000	783.5	1267	867.5	190
	KHF1120	556	1422	978	195
39CQ 3438	KHF1250	1038	1524	1147	99

Note: The data in table are just for your reference

Fan & Motor (2532~3438)

Unit Size	Fan Model	Max. Motor Power (kW)	Max. Motor Model	Fan Section Length (mm)
				THF/UBF
39CQ 2532	KHF900	45	Y225	2600
	KHF1000	55	Y250	2600
39CQ 2832	KHF1000	55	Y250	2600
	KHF1120	90	Y280	2800
39CQ 3132	KHF1000	55	Y250	2600
	KHF1120	90	Y280	2800
39CQ 3438	KHF1250	90	Y280	2900