



United Technologies

turn to the experts



**AQUASnap**<sup>®</sup>

**30RB/RQ 039S-160S**

**Air-Cooled Liquid Chiller**

**Reversible Air-to-Water Heat Pump**

Nominal cooling capacity: 39.7~157.9 kW ( 30RB )

Nominal cooling capacity: 38.3~150.3 kW ( 30RQ )

Nominal heating capacity: 41.4~158.7 kW ( 30RQ )



## Turn To The Experts

Founded by the inventor of modern air conditioning, Carrier is the world's leader in high-technology heating, air-conditioning and refrigeration solutions. Carrier experts provide sustainable solutions, integrating energy-efficient products, building controls and energy services for residential, commercial, retail, transport and food service customers. Carrier is a part of UTC Building & Industrial Systems, a unit of United Technologies Corp., a leading provider to the aerospace and building systems industries worldwide.

With a broad portfolio of advanced technical patent awards, our global R&D center in Shanghai develops innovative heat, ventilation and air-conditioning (HVAC) solutions.



In 1998, Time magazine named Dr. Carrier one of its 20 most influential builders and titans of the 20<sup>th</sup> century.



## Features

- ✔ The new generation of Aquasnap Puron liquid chillers/air-to-water heat pumps was designed for commercial (air conditioning of offices, hotels etc.) or industrial (low-temperature process chillers etc.) applications.

## Benefits

- ✔ Standard unit with hydronic module including all necessary hydronic components, easy and fast installation to save time, space and money.
- ✔ Low operating sound with no intrusive low-frequency noise, creates a better working/living environment.
- ✔ Environment sound refrigerant HFC-410A of zero ozone depletion potential.
- ✔ Electronic expansion valve (EXV) utilization, several compressors connected in parallel lead to more economical operating cost.
- ✔ Exceptional endurance tests ensure superior reliability for minimizing chiller down-time.

## Economical operation

- ✔ Increased energy efficiency at part load
  - The refrigerant circuit includes several compressors connected in parallel. At part load, around 99% of the operating time, only the compressors that are absolutely necessary operate.
  - The electronic expansion device (EXV) allows operation at a lower condensing pressure (EER, COP and ESEER optimization).
  - Dynamic superheat management for better utilization of the evaporator heat exchange surface.
  - Defrost cycle optimization (30RQ).
- ✔ Reduced maintenance costs
  - Maintenance-free scroll compressors.
  - Fast diagnosis of possible incidents and their history via the Pro-Dialog Plus control.
  - HFC-410A refrigerant is easier to use than other refrigerant blends.

## Quiet operation

- ✔ Compressors
  - Low-noise scroll compressors with low vibration level.
  - The compressor assembly is installed on an independent chassis and supported by anti-vibration mountings.
  - Dynamic suction and discharge piping support, minimizing vibration transmission (Carrier patent).
- ✔ Condenser section
  - Vertical condenser coils.
  - Protection grilles on anti-vibration mountings to protect the heat exchanger against possible shocks.
  - Low-noise latest-generation Flying Bird IV fans (Carrier patent), made of a composite material are now even quieter and do not generate intrusive low-frequency noise.
  - Rigid fan installation for reduced start-up noise (Carrier patent).

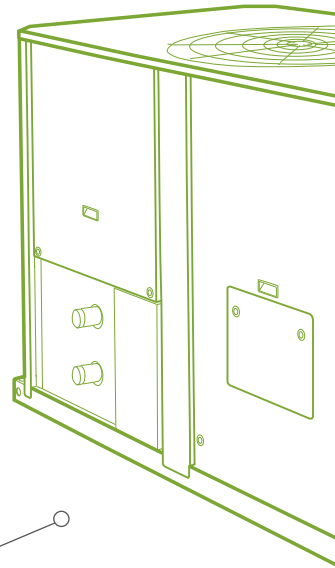

## Environmental care

- ✔ Ozone-friendly HFC-410A refrigerant
  - Chlorine-free refrigerant of the HFC group with zero ozone depletion potential.
  - High-density refrigerant, therefore less refrigerant required.
  - Very efficient - gives an increased energy efficiency ratio.
- ✔ Leak-tight refrigerant circuit
  - Brazed refrigerant connections for increased leaktightness.
  - Reduction of leaks due to reduced vibration levels and elimination of capillary tubes (TXVs).
  - Verification of pressure transducers and temperature sensors without transferring refrigerant charge.

## Easy and fast installation

- ✔ Integrated hydronic module
  - Centrifugal fixed speed water pump.
  - Single or dual pump (as required) with operating time balancing and automatic changeover to the back-up pump if a fault develops.
  - Water filter protecting the water pump against circulating debris.
  - High-capacity membrane expansion tank ensures pressurization of the water circuit.
  - Thermal insulation and frost protection down to -20 , using an electric resistance heater.
- ✔ Physical features
  - The unit has a small footprint and a low height (1330 mm) allowing it to blend in with any architectural styles.
  - The unit is enclosed by easily removable panels, covering all components (except condensers and fans).
- ✔ Simplified electrical connections
  - A single power supply point without neutral.
  - Main disconnect switch with high trip capacity.
  - Transformer for safe 24 V control circuit supply included.
- ✔ Fast commissioning
  - Systematic factory operation test before shipment.
  - Quick-test function for step-by-step verification of the instruments, electrical components and motors.



## Superior reliability

- ✔ State-of-the-art concept
  - Cooperation with specialist laboratories and use of limit simulation tools (finite element calculations) for the design of the critical components, e.g. motor supports, suction/discharge piping etc.
- ✔ Exceptional endurance tests
  - Corrosion resistance tests in salt mist in the laboratory.
  - Accelerated ageing test on components that are submitted to continuous operation: compressor piping, fan supports.
  - Transport simulation test in the laboratory on a vibrating table.

## Pro-Dialog Plus Control

Pro-Dialog Plus combines intelligence with operating simplicity. The control constantly monitors all machine parameters and precisely manages the operation of compressors, expansion devices, fans and of the evaporator water pump for optimum energy efficiency.

### User-friendly interface

- The new backlighted LCD interface includes a manual control potentiometer to ensure legibility under any lighting conditions. The information is in clear text and can be displayed in English.
- Unit uses intuitive tree-structure menus, similar to the Internet navigators. They are user-friendly and permit quick access to the principal operating parameters: number of compressors operating, suction/discharge pressure, compressor operating hours, set point, air temperature, entering/leaving water temperature.

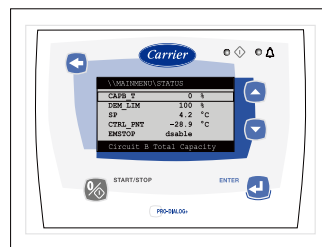

### Advanced control function

- Unit provides different control mode including LOCAL/REMOTE/CCN.
- Remote control function including: Unit ON/OFF, dual set point control, demand limit control, user safety interlock, water pump control, operation indication, circuit alarm and alert etc.
- Enable automatic reset of leaving water temperature according to return water temperature or outside air temperature to ensure optimum energy efficiency.
- Control algorithm prevents excessive compressor cycling and permits reduction of the water quantity in the hydronic circuit (Carrier patent).
- Automatic compressor unloading in case of abnormally high condensing pressure. If an abnormal incident occurs (e.g. fouled condenser coil, fan failure), Aquasnap continues to operate, but at reduced capacity.

### Powerful diagnostics

- A quick test of all unit components and control points to verify the correct operation of every switch, circuit breaker, contactor etc. at the start of the chiller.
- Real-time monitor all the operation parameter, and alarm when necessary.
- Control system is facilitated with RS485 serial communication port for remote diagnosis or special diagnosis tools.

### Sufficient safety measures

- Password protection in case of mishandling.
- Unit is protected against: compressor reverse, low chilled water temperature, high/low refrigerant pressure, excessive current, motor overload.

### Group control

- Master/slave control of two chillers operating in parallel with operating time equalization and automatic changeover in case of a unit fault.
- Communication with other Building Management System (BMS) by selecting BacNet/J-Bus/LonTalk gateway.

## Technical Specifications

### Performance data

30RB		039S	060S	080S	100S	120S	160S
Nominal cooling capacity*	kW	39.7	59.8	80.5	100.9	118.0	157.9
Compressor power input	kW	13.0	20.4	27.1	34.4	41.7	54.8
EER	kW/kW	2.88	2.84	2.80	2.80	2.73	2.72
Operating weight							
Standard unit with fixed speed single pump	kg	488	545	562	877	912	1114
Unit with fixed speed dual pump	kg	514	571	588	922	960	1151
Unit without hydronic module	kg	458	515	533	845	876	1075
Refrigerant		HFC-410A					
Circuit A	kg	8.5	15.0	15.5	20.0	25.0	16.0
Circuit B	kg	-	-	-	-	-	16.0
Compressor		Hermetic scroll compressors, 48.3r/s					
Circuit A		2	2	2	3	3	2
Circuit B		-	-	-	-	-	2
Number of capacity stages		2	2	2	3	3	4
Minimum capacity	%	50	50	50	33	33	25
Control		Pro-Dialog Plus					
Condenser		Grooved copper tubes and aluminium fins					
Fans		Axial Flying Bird IV with rotating shroud					
Quantity		1	1	1	2	2	2
Total air flow	l/s	3800	3800	5300	7600	7600	10600
Fan speed	rpm	720	720	960	720	720	960
Evaporator		Braze plate heat exchanger					
Water volume	l	2.6	4.0	5.6	9.9	11.3	14.7
Nominal water flow rate	l/s	1.9	2.9	3.8	4.8	5.6	7.5
Unit internal water pressure drop	kPa	41	60	65	55	63	78
Max. water-side operating pressure without hydronic module	kPa	1000	1000	1000	1000	1000	1000
Hydronic module		Pump, Victaulic screen safety valve, expansion tank, purge valves etc.					
Water pump		Horizontal single-stage centrifugal pump					
Water head external to chiller							
Single pump at nominal water flow rate	kPa	227	194	196	223	201	181
Dual pump at nominal water flow rate	kPa	223	190	191	217	194	168
Expansion tank	l	12	12	12	35	35	35
Max. water-side operating pressure with hydronic module	kPa	400	400	400	400	400	400
Water connection		Victaulic					
Diameter		DN50	DN50	DN50	DN65	DN65	DN65
Electrical data		400V-3Ph-50Hz					
Main power supply		Via internal transformer					
Control power supply							
Nominal unit operating current draw	A	28	41	58	70	86	116
Maximum operating current draw	A	35	51	68	84	99	136
Maximum start-up current	A	115	146	212	199	243	280
Total fan power input	kW	0.8	0.7	1.6	1.5	1.5	3.2
Pump power input (single pump)	kW	1.3	1.3	1.8	2.1	2.3	4.7
Pump power input (dual pump)	kW	1.3	1.3	1.8	2.1	2.3	4.7

\* Nominal cooling mode - evaporator entering/leaving water temperature 12/7 °C, outside air temperature 35 °C;  
Evaporator fouling factor 0.018m<sup>2</sup>K/kW.

# Technical Specifications

## Performance data

30RQ		039S	060S	078S	100S	120S	160S
Nominal cooling capacity*	kW	38.3	58.6	74.3	99.0	113.8	150.3
Compressor power input, cooling mode	kW	12.3	19.2	26.6	33.3	40.0	54.1
EER	kW/kW	2.92	2.80	2.61	2.84	2.74	2.63
Nominal heating capacity*	kW	41.4	61.3	77.7	101.4	117.2	158.7
Compressor power input, heating mode	kW	12.6	18.0	24.6	30.5	35.9	48.7
COP	kW/kW	3.08	3.09	2.94	3.15	3.11	3.04
Operating weight							
Standard unit with fixed speed single pump	kg	535	582	590	935	995	1117
Unit with fixed speed dual pump	kg	561	608	616	980	1043	1127
Unit without hydronic module	kg	506	552	560	903	959	1078
Refrigerant		HFC-410A					
Circuit A	kg	12.5	17.5	16.5	28.5	33.0	18.5
Circuit B	kg	-	-	-	-	-	18.5
Compressor		Hermetic scroll compressors, 48.3r/s					
Circuit A		2	2	2	3	3	2
Circuit B		-	-	-	-	-	2
Number of capacity stages		2	2	2	3	3	4
Minimum capacity	%	50	50	50	33	33	25
Control		Pro-Dialog Plus					
Air heat exchanger		Grooved cooper tubes and aluminium fins					
Fans		Axial Flying Bird IV with rotating shroud					
Quantity		1	1	1	2	2	2
Total air flow	l/s	3800	5300	5300	7600	7600	10600
Fan speed	rpm	720	960	960	720	720	960
Water heat exchanger		Brazen plate heat exchanger					
Water volume	l	2.6	4.0	5.6	9.9	11.3	14.7
Nominal water flow rate, cooling mode	l/s	1.8	2.8	3.5	4.7	5.4	7.2
Nominal water flow rate, heating mode	l/s	2.0	2.9	3.7	4.8	5.6	7.6
Nominal pressure drop, cooling mode	kPa	38	56	52	53	60	72
Nominal pressure drop, heating mode	kPa	45	62	61	55	64	78
Max. water-side operating pressure without hydronic module	kPa	1000	1000	1000	1000	1000	1000
Hydronic module		Pump, Victaulic screen filter, safety valve, expansion tank, purgevalves etc.					
Water pump		Horizontal single-stage centrifugal pump					
Water head external to chiller							
Single pump at nominal water flow rate, cooling mode	kPa	230	209	211	223	205	188
Dual pump at nominal water flow rate, cooling mode	kPa	226	205	207	217	198	176
Single pump at nominal water flow rate, heating mode	kPa	219	205	197	219	193	176
Dual pump at nominal water flow rate, heating mode	kPa	215	200	192	213	185	163
Expansion tank	l	12	12	12	35	35	35
Max. water-side operating pressure with hydronic module	kPa	400	400	400	400	400	400
Water connection		Victaulic					
Diameter		DN50	DN50	DN50	DN65	DN65	DN65
Electrical data		400V-3Ph-50Hz					
Main power supply		Via internal transformer					
Control power supply							
Nominal unit operating current draw	A	28	43	58	70	86	116
Maximum operating current draw	A	35	53	68	84	99	136
Maximum start-up current	A	115	148	212	199	243	280
Total fan power input, cooling mode	kW	0.8	1.7	1.8	1.5	1.5	3.1
Total fan power input, heating mode	kW	0.9	1.9	1.9	1.8	1.8	3.5
Pump power input (single pump)	kW	1.3	1.4	1.7	2.1	2.4	4.6
Pump power input (dual pump)	kW	1.3	1.4	1.7	2.1	2.4	4.6

\* Nominal cooling mode - evaporator entering/leaving water temperature 12/7 °C, outside air temperature 35 °C;  
 Nominal heating mode - water heat exchange entering/leaving water temperature 40/45 °C, outside air temperature 7 °C;  
 Water heat exchanger fouling factor 0.018m<sup>2</sup>K/kW.

## Cooling Capacities, 30RB039S~160S

		Outside air temperature C														
Model	LWT	25			30			35			40			45		
		CAP	COMP	FLOW	CAP	COMP	FLOW	CAP	COMP	FLOW	CAP	COMP	FLOW	CAP	COMP	FLOW
		C	kW	kW	l/s	kW	kW	l/s	kW	kW	l/s	kW	kW	l/s	kW	kW
039S	5	40.9	10.7	2.0	39.2	11.6	1.9	37.4	12.8	1.8	35.1	14.0	1.7	32.5	15.6	1.6
060S	5	62.8	16.4	3.0	59.9	18.1	2.9	55.9	20.1	2.7	51.2	22.2	2.4	46.3	24.7	2.2
080S	5	85.4	23.4	4.1	80.7	25.4	3.9	75.6	27.0	3.6	70.0	30.5	3.3	64.0	33.4	3.1
100S	5	107.1	27.8	5.1	101.6	30.4	4.9	95.3	33.3	4.5	88.2	36.6	4.2	80.4	40.0	3.8
120S	5	125.6	34.3	6.0	118.9	36.8	5.7	111.8	39.6	5.3	104.2	42.7	5.0	95.4	46.7	4.6
160S	5	167.3	45.2	8.0	158.2	49.0	7.6	148.3	53.1	7.1	137.6	57.8	6.6	125.9	63.1	6.0
039S	6	42.1	10.8	2.0	40.4	11.7	1.9	38.5	12.9	1.8	36.1	14.2	1.7	33.5	15.7	1.6
060S	6	65.0	16.5	3.1	62.1	18.3	3.0	57.8	20.3	2.8	53.1	22.4	2.5	48.0	24.8	2.3
080S	6	87.9	23.6	4.2	83.1	25.6	4.0	77.8	27.3	3.7	72.1	30.7	3.4	66.0	33.6	3.1
100S	6	110.2	28.2	5.3	104.6	30.8	5.0	98.0	33.7	4.7	90.8	37.0	4.3	82.8	40.4	4.0
120S	6	129.0	35.1	6.2	122.2	37.7	5.8	114.9	40.4	5.5	107.0	43.6	5.1	98.4	47.0	4.7
160S	6	172.6	45.9	8.2	163.2	49.7	7.8	153.0	53.9	7.3	141.9	58.6	6.8	129.9	63.9	6.2
039S	7	43.3	10.9	2.1	41.5	11.8	2.0	39.7	13.0	1.9	37.1	14.3	1.8	34.4	15.9	1.6
060S	7	67.2	16.6	3.2	64.2	18.4	3.1	59.8	20.4	2.9	55.0	22.5	2.6	49.7	25.0	2.4
080S	7	90.5	23.8	4.3	85.6	25.9	4.1	79.9	27.5	3.8	74.3	30.9	3.5	67.8	33.8	3.2
100S	7	113.5	28.6	5.4	107.7	31.2	5.1	100.9	34.4	4.8	93.4	37.5	4.5	85.2	40.9	4.1
120S	7	132.6	35.8	6.3	125.5	38.5	6.0	118.0	41.7	5.6	109.8	44.5	5.2	101.0	47.8	4.8
160S	7	178.1	46.7	8.5	168.4	50.5	8.0	157.9	54.8	7.5	146.5	59.5	7.0	134.1	64.7	6.4
039S	8	44.5	11.1	2.1	42.7	12.0	2.0	40.7	13.2	1.9	38.2	14.5	1.8	35.4	16.1	1.7
060S	8	69.4	16.8	3.3	66.4	18.6	3.2	61.9	20.6	3.0	56.9	22.7	2.7	51.5	25.1	2.5
080S	8	93.2	24.1	4.5	88.0	26.1	4.2	82.4	27.8	3.9	76.5	31.2	3.7	69.8	34.2	3.3
100S	8	116.8	29.0	5.6	110.7	31.7	5.3	103.7	34.7	5.0	96.1	38.0	4.6	87.6	41.4	4.2
120S	8	136.4	36.2	6.5	128.8	39.3	6.2	121.0	42.3	5.8	112.6	45.5	5.4	103.6	48.8	4.9
160S	8	183.6	47.5	8.8	173.5	51.3	8.3	162.8	55.6	7.8	151.1	60.4	7.2	138.4	65.5	6.6
039S	10	46.9	11.3	2.2	45.1	12.3	2.2	43.0	13.5	2.1	40.3	14.8	1.9	37.3	16.4	1.8
060S	10	74.0	17.1	3.5	70.7	18.8	3.4	66.1	20.9	3.2	60.9	23.0	2.9	55.3	25.5	2.6
080S	10	98.6	24.6	4.7	93.2	26.6	4.5	87.4	28.3	4.2	81.0	31.7	3.9	74.0	34.6	3.5
100S	10	123.5	29.9	5.9	117.0	32.6	5.6	109.5	35.6	5.2	101.4	38.9	4.8	92.4	42.4	4.4
120S	10	143.9	37.1	6.9	136.0	40.2	6.5	127.5	43.7	6.1	118.4	47.4	5.7	108.7	50.7	5.2
160S	10	195.1	48.5	9.3	184.4	52.8	8.8	172.9	57.4	8.3	160.6	62.2	7.7	147.2	67.4	7.0

Legend:  
 LWT leaving water temperature  
 CAP cooling capacity  
 COMP compressor power input  
 FLOW water flow

Application data:  
 Standard units, refrigerant: HFC-410A  
 Evaporator temperature rise: 5 C  
 Fouling factor: 0.018 m<sup>2</sup>K/kW



# Operating Range, 30RB039S~160S

## Cooling mode

Evaporator	Minimum	Maximum
Entering water temperature at start-up	7.5 °C	30 °C
Leaving water temperature during operation	5 °C	20 °C
Entering/leaving water temperature difference	3K	10K

Condenser	Minimum	Maximum
Outdoor air temperature*	-10 °C	48 °C

\* Maximum outside temperature: For transport and storage of the 30RB/RQ units the minimum and maximum allowable temperatures are -20 °C and +48 °C. It is recommended that these temperatures are used for transport by container.

## Operating range

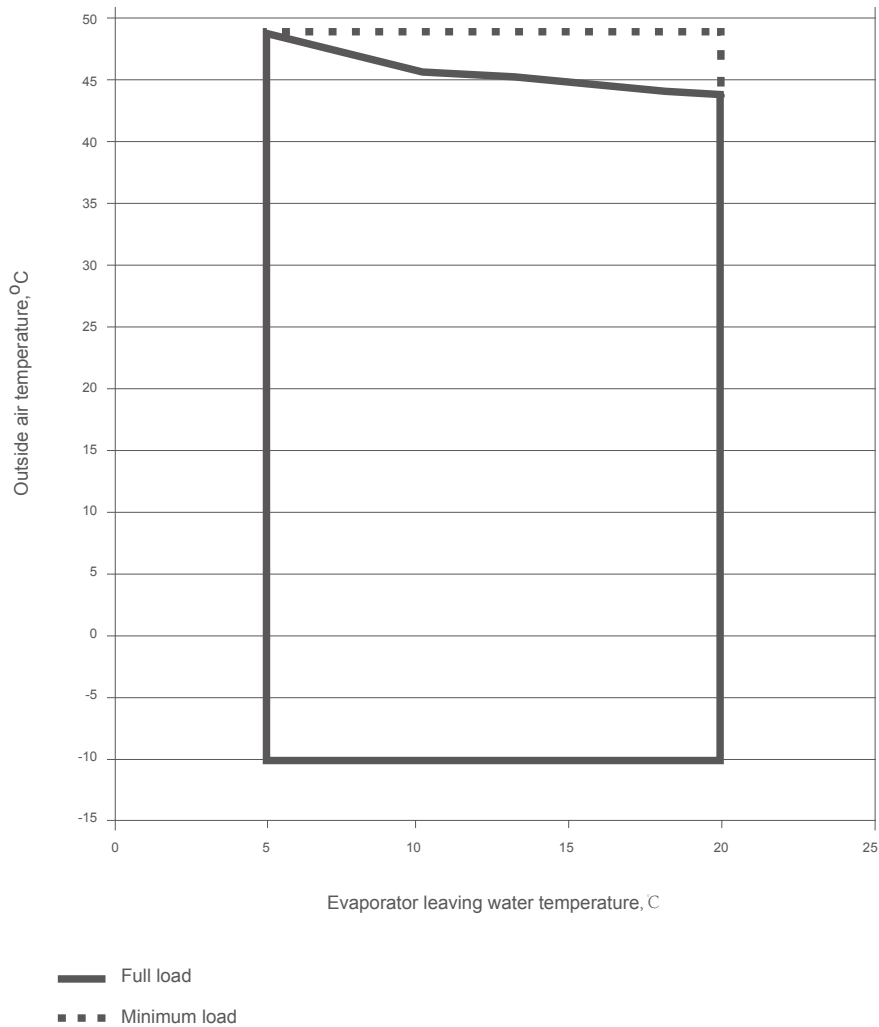

## Operating Range, 30RQ039S~160S

### Cooling mode

Water heat exchanger (Evaporator)	Minimum	Maximum
Entering water temperature at start-up	7.5 C	30 C
Leaving water temperature during operation	5 C	20 C
Entering/leaving water temperature difference	3K	10K
Air heat exchanger (Condenser)	Minimum	Maximum
Outdoor air temperature*	-10 C	48 C

\* Maximum outside temperature: For transport and storage of the 30RB/RQ units the minimum and maximum allowable temperatures are -20 C and +48 C. It is recommended that these temperatures are used for transport by container.

### Heating mode

Water heat exchanger (Condenser)	Minimum	Maximum
Entering water temperature at start-up	8 C	30 C
Leaving water temperature during operation	25 C	55 C
Entering/leaving water temperature difference	3K	10K
Air heat exchanger (Evaporator)	Minimum	Maximum
Outdoor air temperature	-10 C*	40 C

\* Min -15 C during part load operation

#### Operating range - cooling mode

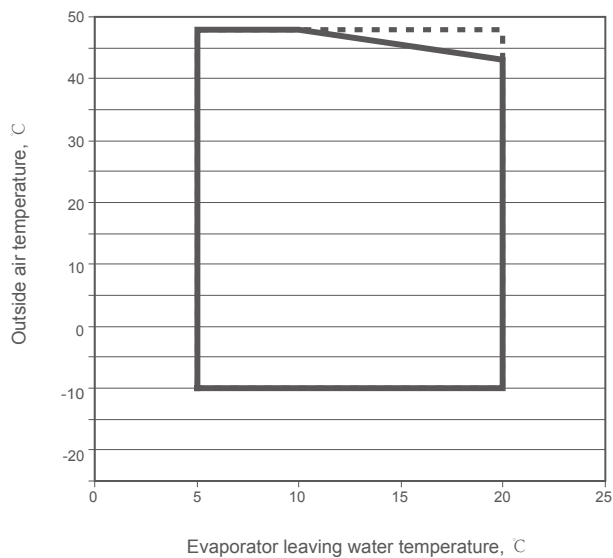

— Full load  
 - - - Minimum load

#### Operating range - heating mode

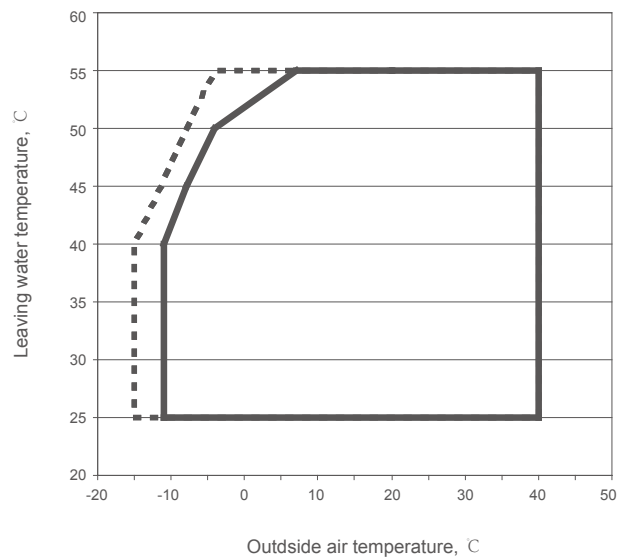

— Full load  
 - - - Minimum load

## Options & accessories

Options	No.	Description	Advantages	Use
Blygold PoluAl	002B	Coils with factory-applied Blygold Polual treatment	Improved corrosion resistance, recommended for heavy marine and industrial environments	30RB039-160S
Gold Fins	003A	Fins made of pre-treated aluminium (polyurethane and epoxy)	Improved corrosion resistance, recommended for light marine environments	30RB039-160S
Super low noise	015LS	Acoustic compressor enclosure and low speed fans	Super low operating noise	30RB039-160S 30RQ039-160S
Soft starter	025	Electronic compressor starter	Reduced compressor start-up current	30RB039S-080S 30RQ039S-078S
Winter operation	028	Fan speed control by frequency inverter	Stable operation between -10 °C and -20 °C outdoor air temperature	30RB039S-080S
Fixed speed dual pump hydronic module	116C	Provide fixed speed dual pumps of 200KPa external pressure	Easy and fast installation, operating safety	30RB039-160S 30RQ039-160S
Unit without hydronic module	116D	Flexible for customer to purchase and install the water components by themselves	-	30RB039-160S 30RQ039-160S
J-Bus gateway	148B	Two-directional communication board with J-Bus protocol	Easy connection by communication bus to a building management system	30RB039-160S 30RQ039-160S
BacNet gateway	148C	Two-directional communication board with BacNet protocol	Easy connection by communication bus to a building management system	30RB039-160S 30RQ039-160S
LonTalk gateway	148D	Two-directional communication board with LonTalk protocol	Easy connection by communication bus to a building management system	30RB039-160S 30RQ039-160S



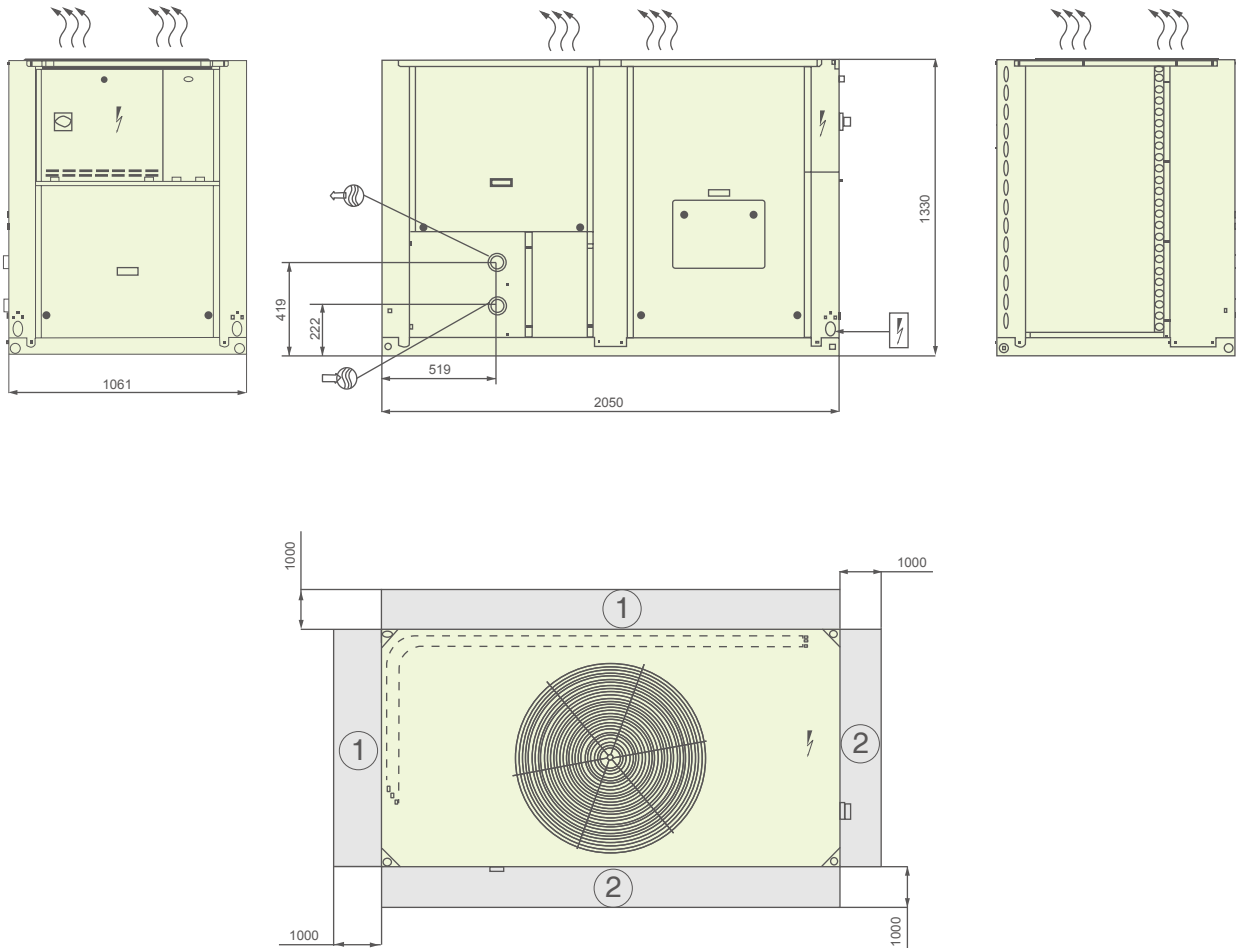

## Dimensions/Clearances

30RB039S~080S/30RQ039S-078S



### Legend:

All dimensions are given in mm

-  Control box
-  Water outlet
-  Water inlet
- ① Required clearances for air entry
- ② Recommended space for maintenance
-  Air outlet - do not obstruct
-  Power supply inlet



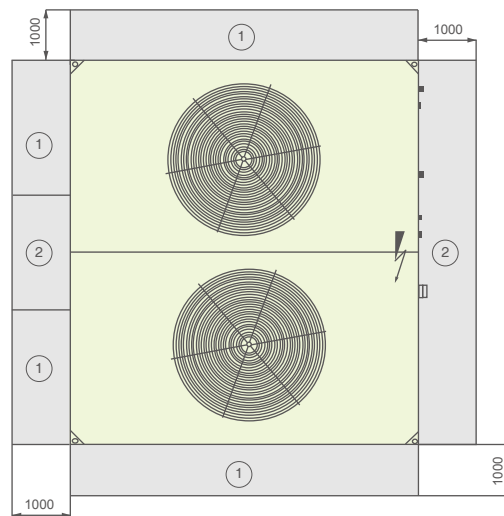
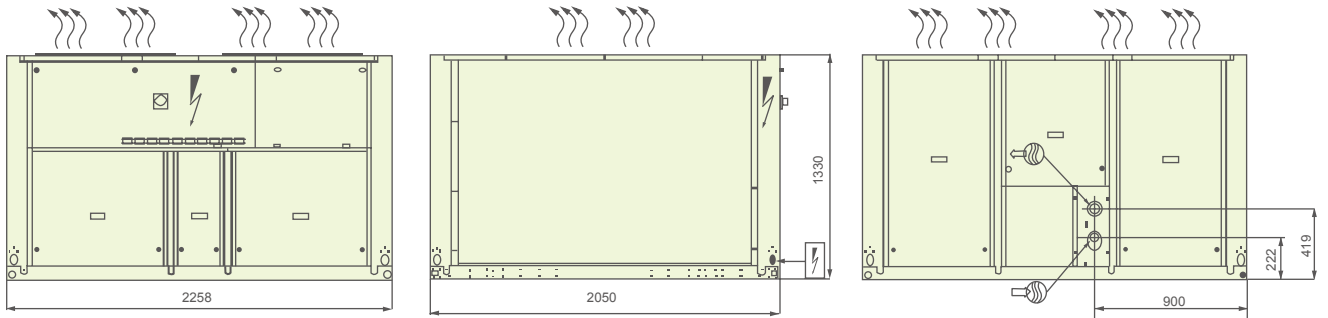

## Dimensions/Clearances

30RB100S~160S/30RQ100S-160S



**Legend:**

All dimensions are given in mm

-  Control box
-  Water outlet
-  Water inlet
- ① Required clearances for air entry
- ② Recommended space for maintenance
-  Air outlet - do not obstruct
-  Power supply inlet

## Multiple Chiller Installation

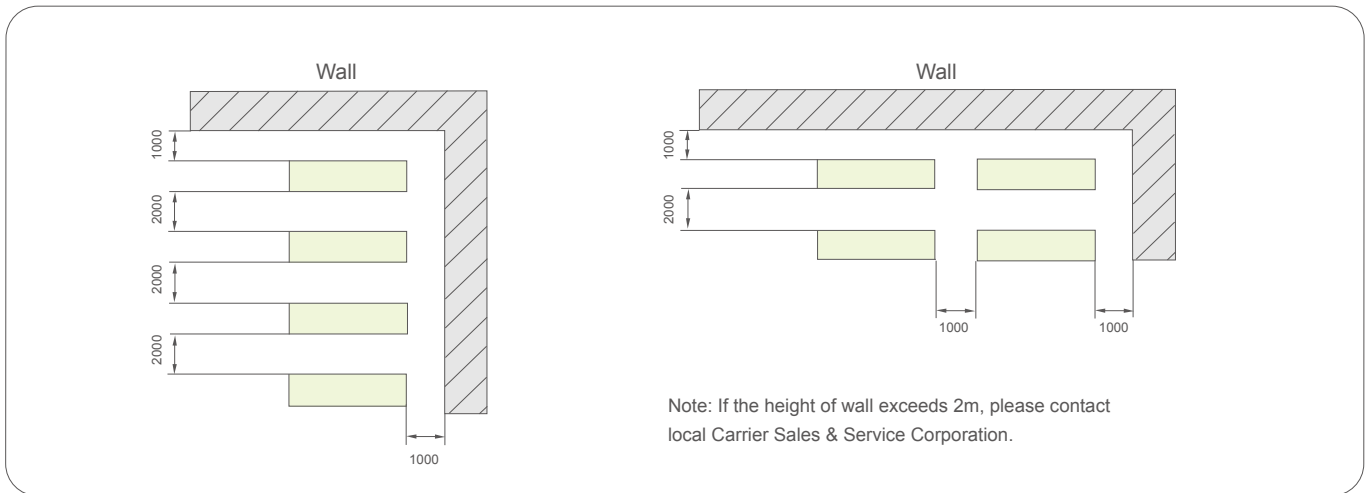

## Multiple Chiller Installation

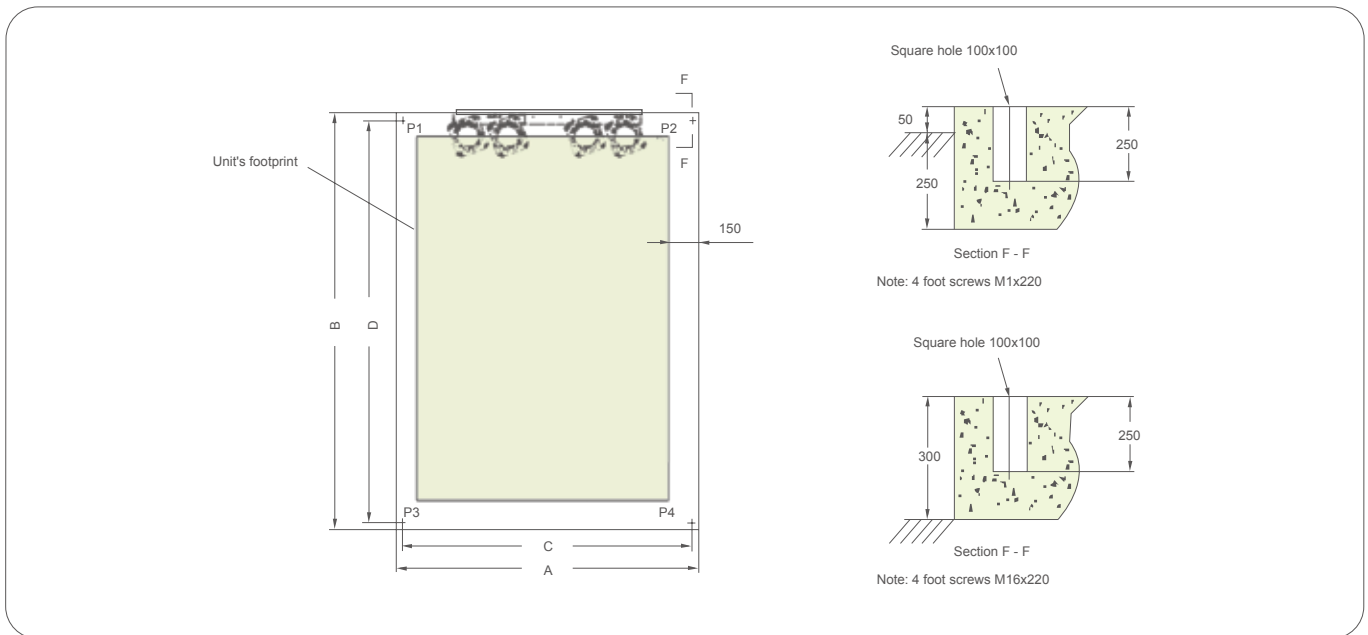

Models	Dimensions (mm)				Weight distribution (kg)				Operating weight
	A	B	C	D	P1	P2	P3	P4	
30RB039S	1061	2050	1017	2002	159	147	87	94	488
30RB060S	1061	2050	1017	2002	176	154	100	115	545
30RB080S	1061	2050	1017	2002	181	159	104	118	562
30RB100S	2258	2050	2214	2002	239	303	187	148	877
30RB120S	2258	2050	2214	2002	246	310	199	157	912
30RB160S	2258	2050	2214	2002	312	357	237	207	1114
30RQ039S	1061	2050	1017	2002	174	161	96	103	535
30RQ060S	1061	2050	1017	2002	188	164	107	123	582
30RQ078S	1061	2050	1017	2002	190	167	109	124	590
30RQ100S	2258	2050	2214	2002	255	323	199	158	935
30RQ120S	2258	2050	2214	2002	268	338	217	171	995
30RQ160S	2258	2050	2214	2002	313	358	238	208	1117

# Hydronic Connections

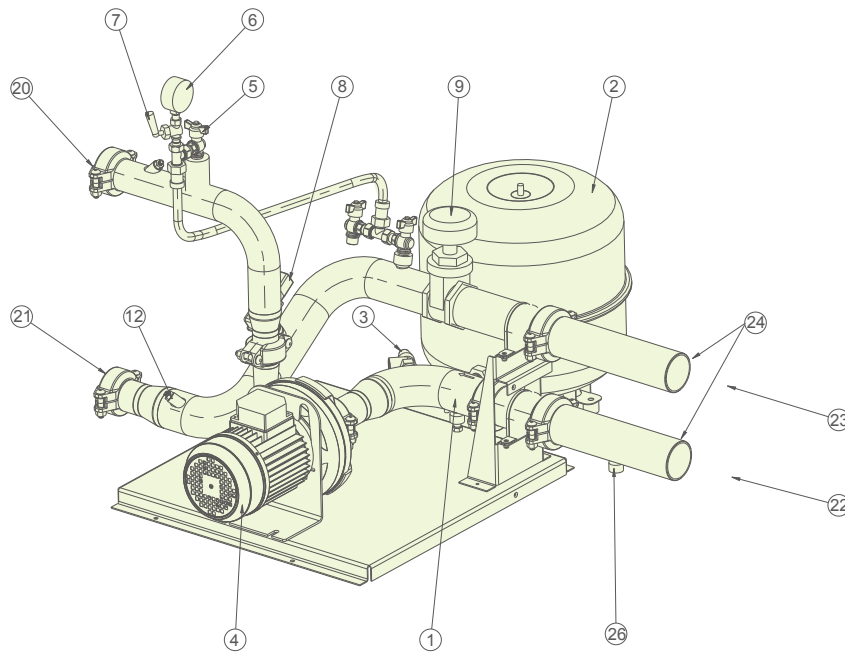
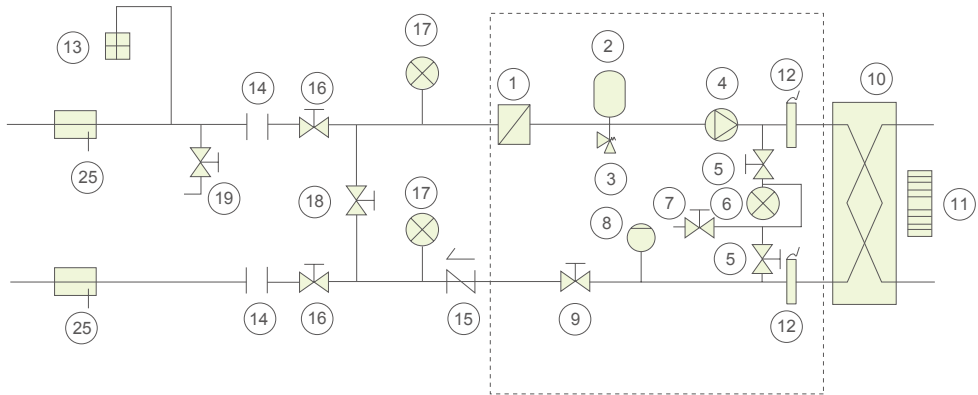

Legend:  
Components of the unit and hydronic module

- 1 Victaulic screen filter
- 2 Expansion tank
- 3 Safety valve
- 4 Water pump
- 5 Purge valve and pressure tap
- 6 Pressure gauge
- 7 System air vent
- 8 Flow switch
- 9 Flow control valve
- 10 Brazed plate heat exchanger
- 11 Evaporator frost protection heater
- 12 Temperature sensor

Installation components

- 13 Air vent
- 14 Flexible connection
- 15 Check valve
- 16 Shut-off valve
- 17 Pressure gauge
- 18 Frost protection bypass valve  
(must have when shut-off valves [16] are closed during winter)
- 19 Charge valve
- 20 Evaporator water inlet
- 21 Evaporator water outlet
- 22 Chiller water inlet
- 23 Chiller water outlet
- 24 Customer water connections (provided with chiller)
- 25 Temperature probe well
- 26 System drain valve

## Unit Internal Water Pressure Drop

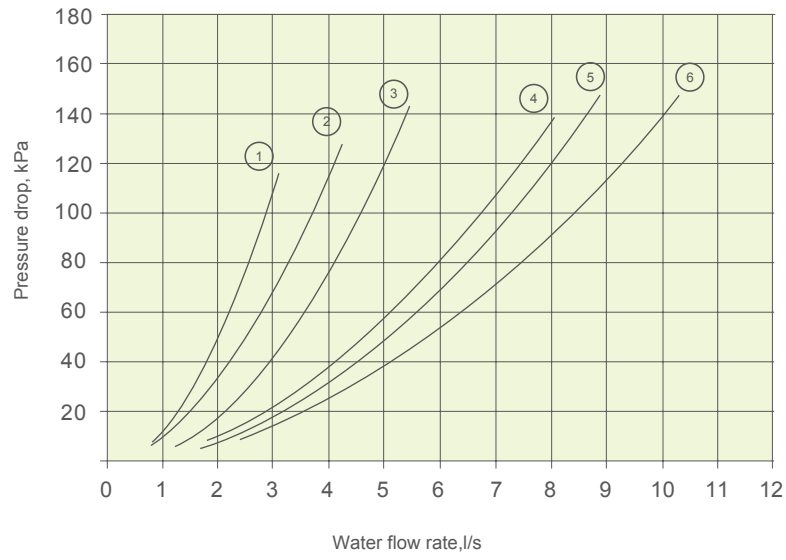

- ① 30RB039S/30RQ039S      ② 30RB060S/30RQ060S      ③ 30RB080S/30RQ078S  
 ④ 30RB100S/30RQ100S      ⑤ 30RB120S/30RQ120S      ⑥ 30RB160S/30RQ160S

## Available Static System Pressure

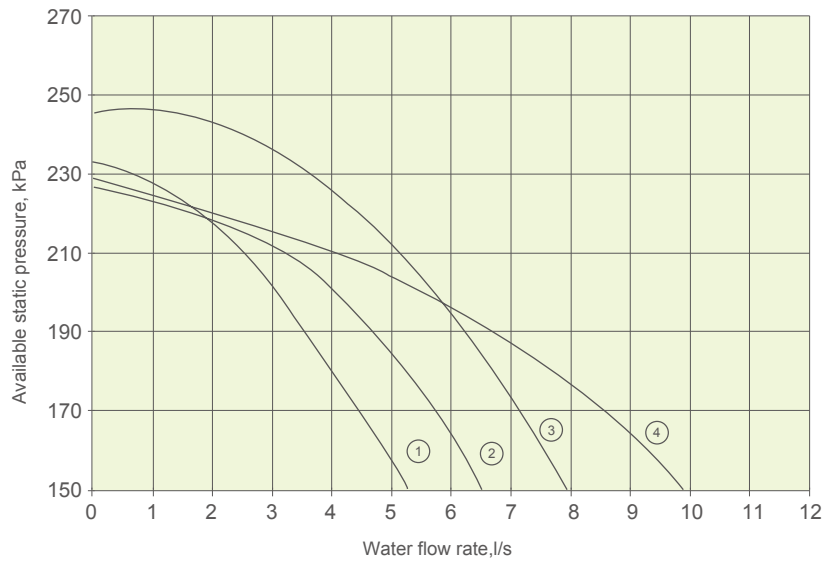

- ① 30RB039S~060S/30RQ039S~060S      ② 30RB080S/30RQ078S  
 ③ 30RB100S~120S/30RQ100S~120S      ④ 30RB160S/30RQ160S



## Minimum Water Loop Volume

For better control of leaving water temperature, the water loop minimum capacity is given by the formula:

$$\text{Capacity} = \text{CAP (kW)} \times \text{N Liters}$$

CAP: Unit's nominal cooling capacity

Application		N
Comfort air conditioning	30RB039S~160S/30RQ039S~160S	3.5
Process cooling	30RB039S~160S/30RQ039S~160S	Should be greater than 3.5 for better water temperature control

It is often necessary to add a buffer water tank to the circuit in order to achieve the required volume. The tank must itself be internally baffled in order to ensure proper mixing of the liquid (water or brine). Refer to the examples below.

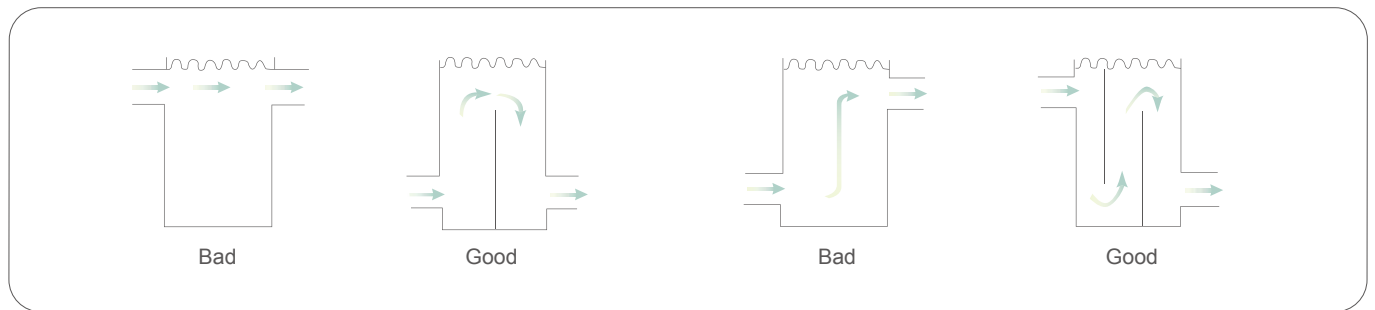

## Maximum Water Loop Volume

The expansion tank of the unit with hydronic module limits the maximum water volume, refer to below sheet:

		30RB039S~080S/30RQ039S~078S			30RB100S~160S/30RQ100S~160S		
Water-side static pressure	kPa	100	200	300	100	200	300
Pure water	L	600	400	200	1680	1120	560
10%EG	L	450	300	150	1260	840	420
20%EG	L	330	220	110	930	620	310
30%EG	L	270	180	90	750	500	250
40%EG	L	225	150	75	630	420	210

EG: Ethylene glycol

# Field Control Wiring

30RB039S~080S/30RQ039S~078S

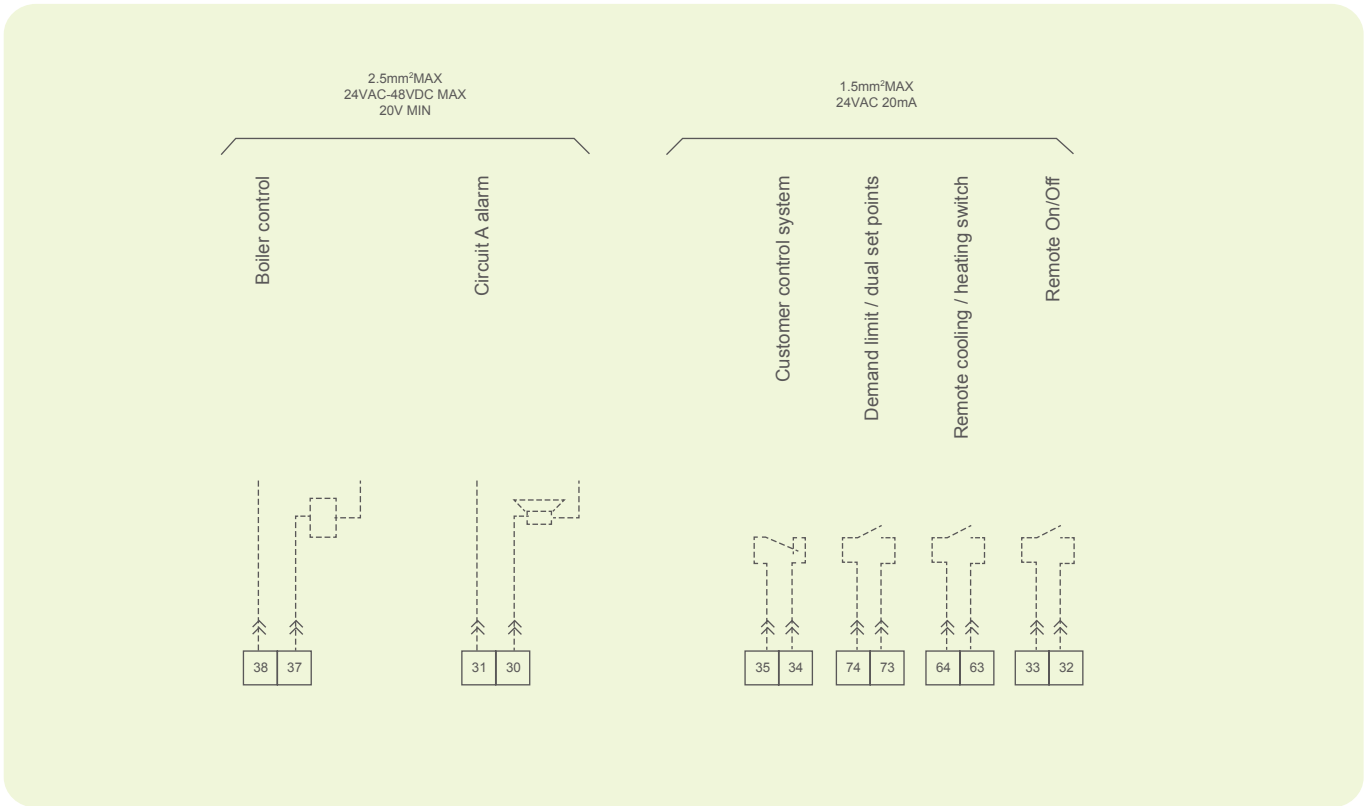

30RB100S~160S/30RQ100S~160S

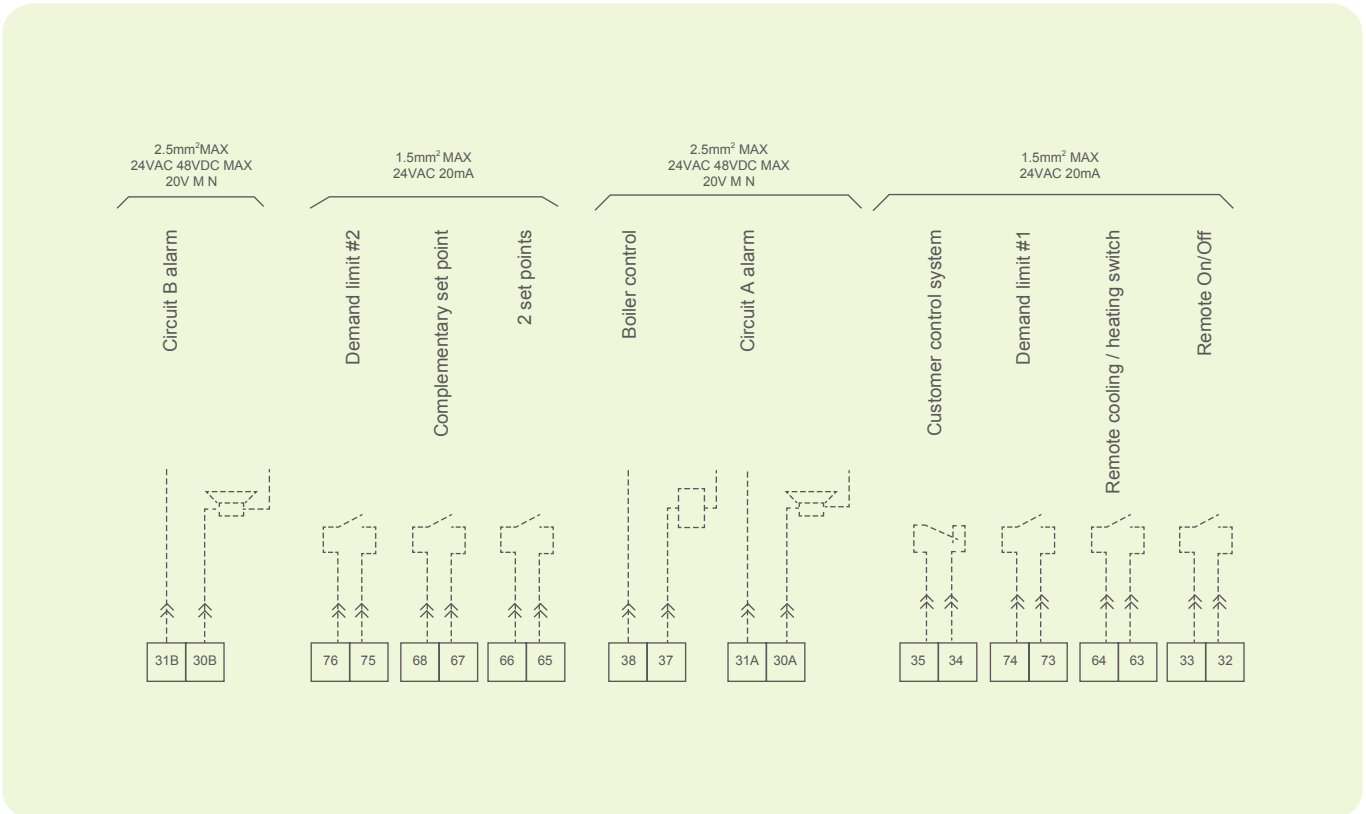



Carrier improves the world around us; Carrier improves people's lives; our products and services improve building performance; our culture of improvement will not allow us to rest when it comes to the environment.



The Manufacturer reserves the right to change any product specifications without prior notices  
© All Rights Reserved Carrier

Version:	CAT_NGA-E-1411_02
Supersede:	CAT_NGA-E-1207_01
Effective Date:	Nov, 2014