



United Technologies

turn to the experts



**AQUAFORCE**<sup>®</sup>

**30XA/XQ**

**Air-Cooled Liquid Chiller**

**Reversible Air-to-Water Heat Pump**

Nominal cooling capacity: 274–1518kW ( 30XA )

Nominal cooling capacity: 315–1471kW ( 30XQ )

Nominal heating capacity: 311–1412kW ( 30XQ )



## Turn To The Experts

Founded by the inventor of modern air conditioning, Carrier is the world's leader in high-technology heating, air-conditioning and refrigeration solutions. Carrier experts provide sustainable solutions, integrating energy-efficient products, building controls and energy services for residential, commercial, retail, transport and food service customers. Carrier is a part of UTC Building & Industrial Systems, a unit of United Technologies Corp., a leading provider to the aerospace and building systems industries worldwide.

With a broad portfolio of advanced technical patent awards, our global R&D center in Shanghai develops innovative heat, ventilation and air-conditioning (HVAC) solutions.



In 1998, Time magazine named Dr. Carrier one of its 20 most influential builders and titans of the 20<sup>th</sup> century.



## Features

- ✔ The Aquaforce liquid chillers are the premium solution for industrial and commercial applications where installers, consultants and building owners require optimal performances and maximum quality.

## Benefits

- ✔ Extremely high full load and part load energy efficiency leads to extremely low operation cost.
- ✔ Low operating sound with no intrusive low-frequency noise, creates a better working/living environment.
- ✔ Environmentally sound refrigerant HFC-134a of zero ozone depletion potential.
- ✔ Easy and fast installation to reduce on-site installation time.
- ✔ Exceptional endurance tests ensure superior reliability to minimize chiller down-time.

## Economical operation

- ✔ Extremely high full load and part load energy efficiency:
  - New twin-rotor screw compressor equipped with a high efficiency motor and a variable capacity valve that permits exact matching of the cooling capacity to the load.
  - Flooded multi-pipe evaporator to increase the heat exchange efficiency, configured with aluminium cladding (standard) to improve thermal insulation and prevent energy loss.
  - Electronic expansion device allows operation at a lower condensing pressure and improved utilization of the evaporator heat exchange surface (superheat control).
  - Economizer system with electronic expansion device permits a considerable increase in cooling capacity and contributes to optimised energy efficiency of the chiller installation.
  - DX free cooling system developed for building that require year-round cooling and in the coldest regions increase energy efficiency and significant energy savings (EER~15 to 30).
  - Average COP of 3.2 at nominal conditions and average integrated part load value (IPLV) of 4.4.



Economizer system

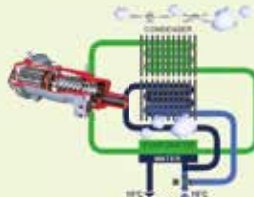

DX free cooling system

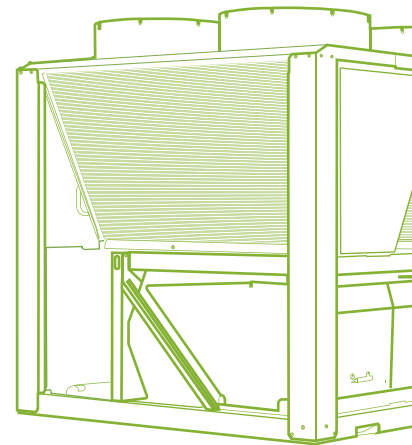

## Quiet operation

- ✔ Compressors
  - Discharge dampers integrated in the oil separator (Carrier patent).
  - Acoustic compressor and oil separator enclosures (option) reduce theradiated noise.
- ✔ Condenser section
  - Condenser coils in V-shape with an open angle, allows quieter air flow across the coil.
  - Low-noise Flying Bird fans (Carrier patent) enjoy quieter operation and never generate intrusive low-frequency noise.
  - Rigid fan mounting preventing start-up noise (Carrier patent).



New twin screw CARRIER compressor



Flying Bird IV axial flow low noise fan



## Environmental sound

- ✓ HFC-134a refrigerant
  - Refrigerant of the HFC group with zero ozone depletion potential.
- ✓ Leak-tight refrigerant circuit
  - Reduction of leaks as no capillary tubes and flare connections are used.
  - Verification of pressure transducers and temperature sensors without transferring refrigerant charge.



## Easy and fast installation

- ✓ Integrated hydronic module (option)
  - Single or dual pump (as required) with operating time balancing and automatic changeover to the back-up pump if a fault develops.
  - Water filter protecting the water pump against circulating debris.
  - High-capacity membrane expansion tank ensures pressurization of the water circuit.
  - Thermal insulation.
  - Pressure gauge to check filter pollution and measure the system water flow rate.
  - Water flow control valve.
- ✓ Simplified electrical connections
  - Main disconnect switch with high trip capacity.
  - Transformer to supply the integrated control circuit (400/24V).
- ✓ Fast commissioning
  - Systematic factory operation test before shipment.
  - Quick-test function for step-by-step verification of the instruments, expansion devices, fans and compressors.

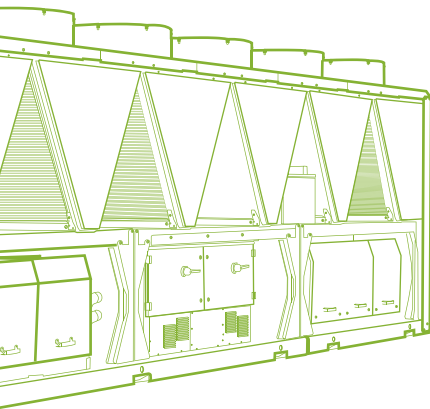

## Absolute reliability

- ✓ Screw compressors
  - Industrial-type screw compressors with oversized bearings and motor cooled by suction gas.
  - All compressor components are easily accessible on site minimizing down-time.
  - Electronic motor protection against overloads and power supply faults (loss of phase, phase reversal).
- ✓ Evaporator
  - Thermal insulation with aluminium cladding for perfect resistance against outside aggression (mechanical and UV protection).
- ✓ Exceptional endurance tests
  - Partnerships with specialised laboratories and use of limit simulation tools (finite element calculation) for the design of critical components.
  - Transport simulation test in the laboratory on a vibrating table. The test is based on a military standard and equivalent to 4000 km by truck.
  - Salt mist corrosion resistance test in the laboratory for increased corrosion resistance.



Cooler aluminium protective cladding

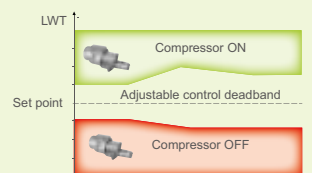



# Technical Insight

## Touch Pilot Control

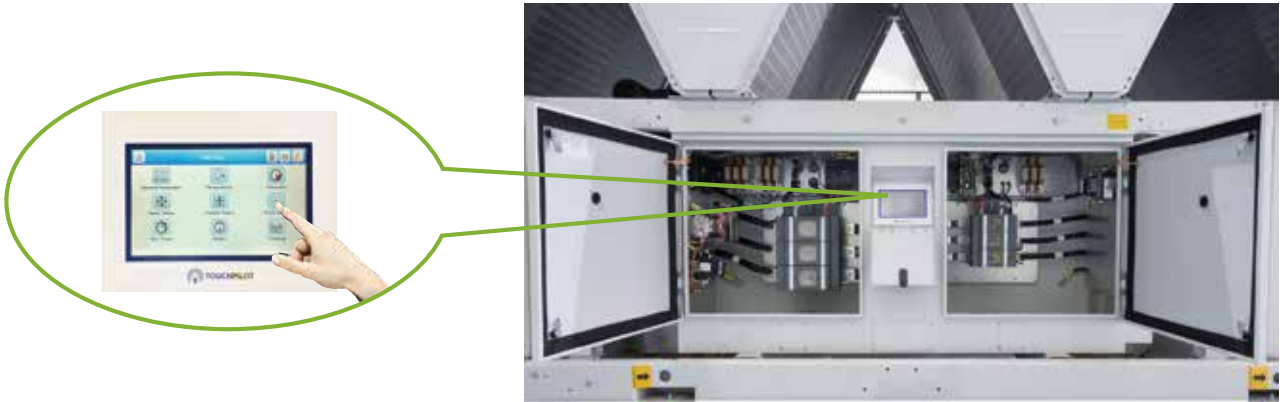

### General Features

- New innovative smart control features:
  - An intuitive and user-friendly, 5" colored interface (7" as option)
  - Screen-shots with concise and clear information in local languages
  - Complete menu, customized for different users (end user, service personnel and Carrier-factory technicians)
  - Easy access to the controller box with touch screen mounting to ensure legibility under any lighting conditions
  - Safe operation and unit setting: password protection ensures that unauthorized people cannot modify any advanced parameters
  - Simple and "smart" intelligence uses data collection from the constant monitoring of all machine parameters to optimise unit operation
  - Night-mode: Cooling capacity management for reduced noise level.
- Energy management:
  - Internal time schedule clock controls chiller on/off times and operation at a second set-point
  - The DCT (Data Collection Tool) records the alarms history to simplify and facilitate service operations

### Remote Management (Standard)

- Units with Touch Pilot control can be easily accessed from the internet, using a PC with an Ethernet connection. This makes remote control quick and easy and offers significant advantages for service operations.
- Equipped with an RS485 serial port that offers multiple remote control, monitoring and diagnostic possibilities. When networked with other Carrier equipment through the CCN (Carrier Comfort Network - proprietary protocol), all components form a HVAC system fully-integrated and balanced through one of the Carrier's network system products, like the Chiller System Manager or the Plant System Manager (optional). The 30XA/XQ also communicates with other building management systems via optional communication gateways.

- The following commands/visualizations are possible from remote connection:
  - Start/Stop of the machine
  - Dual set-point management: Through a dedicated contact is possible to activate a second set-point (example: unoccupied mode)
  - Demand limit setting: To limit the maximum chiller capacity to a predefined value
  - Water pump control: These outputs control the contactors of on/off evaporator water pumps
  - Operation visualization: Indication if the unit is operating or if it's in stand-by (no cooling load)
  - Alarm visualization

### Remote Management (EMM option)

- The Energy Management Module (EMM) offers extended remote control possibilities:
  - Room temperature: Permits set-point reset based on the building indoor air temperature (if Carrier thermostat are installed)
  - Set-point reset: Ensures reset of the cooling set-point based on a 4-20 mA or 0-10 V signal
  - Demand limit: Permits limitation of the maximum chiller power or current based on 0-10 V signal
  - Demand limit 1 and 2: Closing of these contacts limits the maximum chiller power or current to two predefined values
  - User safety: This contact can be used for any customer safety loop; opening the contact generates a specific alarm
  - Ice storage end: When ice storage has finished, this input permits return to the second set-point (unoccupied mode)
  - Time schedule override: Closing of this contact cancels the time schedule effects
  - Out of service: This signal indicates that the chiller is completely out of service
  - Chiller capacity: This analogue output (0-10 V) gives an immediate indication of the chiller capacity
  - Alert indication: This volt-free contact indicates the necessity to carry out a maintenance operation or the presence of a minor fault
  - Compressors running status: Set of outputs (as many as the compressors number) indicating which compressors are running.

# Operating Range, 30XA

## Cooling mode

Evaporator	Min.temperature	Max.temperature
Entering water temperature (at start)	-	45°C
Entering water temperature (during operation)	6.8°C	21°C
Leaving water temperature (during operation)	3.3°C	15°C
Condenser	Min.temperature	Max.temperature
Outdoor air temperature	-10**C	50** (for 30XA0252~1502)****
		46*** (for 30XA0652~1392)****

\* With PT028 "winter operation", outdoor air temperature may down to -20°C. A glycol/water solution or evaporator anti-freeze protection must be used if the air temperature is below 0°C

\*\* Max 55°C during part load operation.

\*\*\* Max 50°C during part load operation

\*\*\*\*30XA0252~1502 - 30XA0252/0302/0352/0402/0452/0502/0602/0702/0752/0852/0902/1002/1352/1502  
30XA0282/0342/0442/0482

30XA0652~1392 - 30XA0652/0712/0762/1052/1152/1252/1312/1392

## Operating range

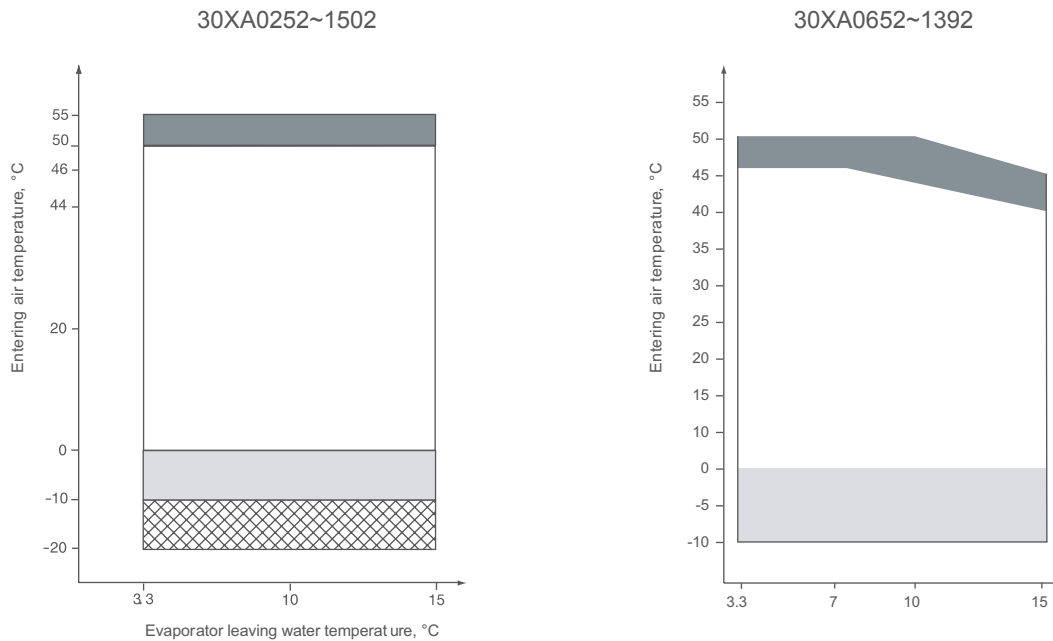

### Legend

Part load

Operating range, standard unit.

Below 0°C air temperature the unit must either be equipped with the evaporator frost protection option (41A or 41B), or the water loop must be protected against frost by using a frost protection solution (by the installer).

Operating range, unit equipped with PT028 "winter operation". In addition the unit must either be equipped with the evaporator frost protection option (41A or 41B), or the water loop must be protected against frost by using a frost protection solution (by the installer).

# Operating Range, 30XQ

## Cooling mode

Water heat exchanger (Evaporator)	Min.temperature	Max.temperature
Entering water temperature (at start)	-	45°C
Entering water temperature (during operation)	6.8°C	21°C
Entering water temperature (during stop)	3°C	55°C
Leaving water temperature (during operation)	4°C	15°C

Air heat exchanger (Condenser)	Min.temperature	Max.temperature
Outdoor air temperature	-10°C	46°C

## Heating mode

Water heat exchanger (Condenser)	Min.temperature	Max.temperature
Entering water temperature (at start)	3.4°C	50°C
Entering water temperature (during operation)	25°C	50°C
Entering water temperature (during stop)	3°C	55°C
Leaving water temperature (during operation)	30°C	55°C

  

Air heat exchanger (Evaporator)	Min.temperature	Max.temperature
Outdoor air temperature	-10°C	21°C

Operating range - cooling mode

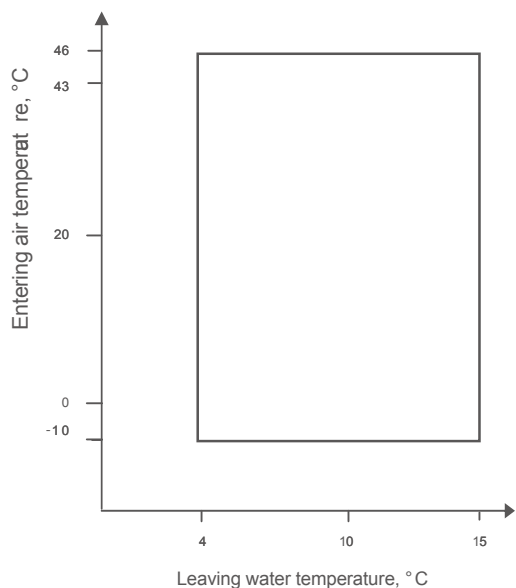

Operating range - heating mode

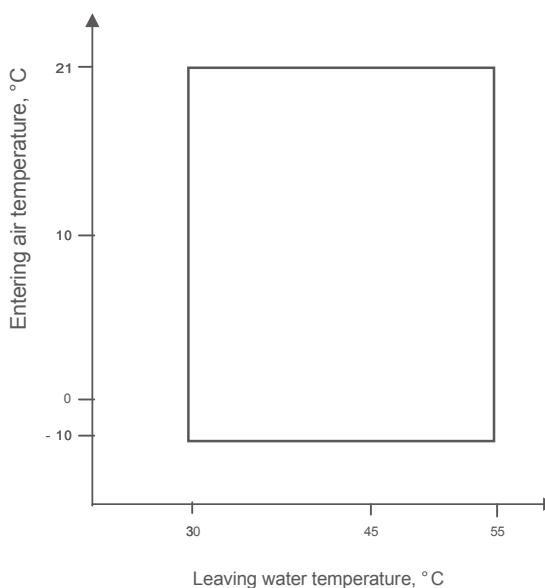



# Technical Specifications

## Unit with Cu/Al condenser coil

30XA		0252	0282	0302	0342	0352	0402	0442	0452	0482	0502	0602	0652	0702
Nominal cooling capacity*	kW	274	278	299	328	327	391	444	452	493	503	619	644	674
Compressor input power	kW	80.5	78.8	87.9	90.5	93.0	113.7	133.7	129.8	143.3	141.3	175.3	187	188.8
EER		3.05	3.19	3.08	3.27	3.20	3.11	3.05	3.19	3.12	3.24	3.22	3.14	3.24
Refrigerant		HFC-134a												
Circuit A	kg	60	97	64	102	70	85	113	85	119	102	102	180	100
Circuit B	kg	64	-	64	-	56	56	-	56	-	56	88	-	95
Circuit C	kg	-	-	-	-	-	-	-	-	-	-	-	-	-
Compressor		Semi-hermetic screw compressor												
Circuit A		1	1	1	1	1	1	1	1	1	1	1	1	1
Circuit B		1	-	1	-	1	1	-	1	-	1	1	-	1
Circuit C		-	-	-	-	-	-	-	-	-	-	-	-	-
Minimum capacity	%	15	30	15	30	15	15	30	15	30	15	15	30	15
Control		Touch Pilot™ control system, electronic expansion valve (EXV)												
Condenser		Cu/Al heat exchanger												
Fans		Axial Flying Bird with rotating shroud												
Quantity		6	5	6	6	7	8	7	8	8	9	11	10	12
Total air flow	l/s	27083	22570	27083	27084	31597	36111	31598	36111	36112	40625	49653	45140	54167
Fan speed	rpm	950	950	950	950	950	950	950	950	950	950	950	950	950
Evaporator		Flooded multi-pipe												
Water content	l	58	49	61	54	61	66	76	70	77	77	79	78	94
Nominal water flow	l/s	13.1	13.3	14.2	15.6	15.6	18.6	21.2	21.5	23.5	24.0	29.5	31	32.1
Nominal water pressure drop	kPa	15	22	15	29	18	34	34	38	41	36	46	37	37
Max. water-side pressure without hydronic module	kPa	1000	1000	1000	1000	1000	1000	1000	1000	1000	1000	1000	1000	1000
Integrated hydronic module (option)		Pump, victaulic screen filter, safety valve, expansion tank, purge valves etc.												
Water pump		Centrifugal pump												
Water head external to chiller (single pump at nominal water flow rate)	kPa	188	198	198	169	181	196	254	247	214	213	-	-	-
Expansion tank	l	50	50	50	50	50	50	50	50	50	50	-	-	-
Max. water-side pressure with hydronic module	kPa	400	400	400	400	400	400	400	400	400	400	-	-	-
Water connection		Victaulic												
Nominal Diameter	DN	125	125	125	125	125	125	125	125	125	125	125	150	150
Electrical data		400V-3Ph-50Hz												
Nominal power supply		Star-delta start												
Start-up method		24V via internal transformer												
Control power supply		24V via internal transformer												
Nominal unit current draw														
Circuit A+B	A	151	147	167	173	182	210	262	238	273	264	320	336	346
Circuit C	A	-	-	-	-	-	-	-	-	-	-	-	-	-
Maximum unit current draw														
Circuit A+B	A	208	180	226	229	243	284	314	316	367	350	423	415	457
Circuit C	A	-	-	-	-	-	-	-	-	-	-	-	-	-
Maximum start-up current														
Circuit A+B	A	274	275	274	308	292	407	504	510	587	510	583	629	616
Circuit C	A	-	-	-	-	-	-	-	-	-	-	-	-	-
Fan and control power	kW	9.2	8.4	9.1	9.8	9.3	12.2	11.8	11.8	14.6	14.0	16.8	18.0	19.0
Unit length	mm	3604	3604	3604	3604	4798	4798	4798	4798	4798	5992	7186	5992	7186
Unit width	mm	2253	2253	2253	2253	2253	2253	2253	2253	2253	2253	2253	2253	2253
Unit height	mm	2297	2297	2297	2297	2297	2297	2297	2297	2297	2297	2297	2297	2297
Unit weight	kg	3764	3523	3793	3820	4317	4761	4571	4823	4900	5393	6392	5250	6544
Operating weight	kg	3830	3578	3860	3875	4380	4830	4641	4900	4984	5470	6480	5328	6640

\* Nominal conditions - evaporator entering/leaving water temperature 12/7°C, outdoor air temperature 35°C; Evaporator fouling factor 0.018m²K/kW

# Technical Specifications

## Unit with Cu/Al condenser coil

30XA		0712	0752	0762	0852	0902	1002	1052	1152	1252	1312	1392	1352	1502
Nominal cooling capacity*	kW	697	729	737	833	906	988	1089	1134	1256	1326	1382	1449	1518
Compressor input power	kW	201	213.5	211	238.8	261.4	288.2	314	328	367	389	409	435.4	436.8
EER		3.15	3.12	3.16	3.18	3.16	3.14	3.16	3.15	3.13	3.12	3.10	3.11	3.18
Refrigerant		HFC-134a												
Circuit A	kg	185	129	195	130	129	140	180	180	190	185	185	112	140
Circuit B	kg	-	88	-	95	103	129	110	114	114	180	185	98	129
Circuit C	kg	-	-	-	-	-	-	-	-	-	-	-	117	130
Compressor		Semi-hermetic screw compressor												
Circuit A		1	1	1	1	1	1	1	1	1	1	1	1	1
Circuit B		-	1	-	1	1	1	1	1	1	1	1	1	1
Circuit C		-	-	-	-	-	-	-	-	-	-	-	1	1
Minimum capacity	%	30	15	30	15	15	15	15	15	15	15	15	10	10
Control		Touch Pilot™ control system, electronic expansion valve (EXV)												
Condenser		Cu/Al heat exchanger												
Fans		Axial Flying Bird with rotating shroud												
Quantity		11	13	12	14	15	16	17	18	19	20	20	20	24
Total air flow	l/s	49654	58681	54168	63194	67708	72222	76738	81252	85766	90280	90280	90280	108333
Fan speed	rpm	950	950	950	950	950	950	950	950	950	950	950	950	950
Evaporator		Flooded multi-pipe												
Water content	l	78	99	78	119	130	140	144	144	144	156	156	224	240
Nominal water flow	l/s	33	34.8	35	39.7	43.2	47.1	52	54	60	63	66	69.1	72.4
Nominal water pressure drop	kPa	43	38	47	39	38	36	42	45	55	53	60	45	48
Max. water-side pressure without hydronic module	kPa	1000	1000	1000	1000	1000	1000	1000	1000	1000	1000	1000	1000	1000
Integrated hydronic module (option)		Pump, victaulic screen filter, safety valve, expansion tank, purge valves etc.												
Water pump		Centrifugal pump												
Water head external to chiller (single pump at nominal water flow rate)	kPa	-	-	-	-	-	-	-	-	-	-	-	-	-
Expansion tank	l	-	-	-	-	-	-	-	-	-	-	-	-	-
Max. water-side pressure with hydronic module	kPa	-	-	-	-	-	-	-	-	-	-	-	-	-
Water connection		Victaulic												
Nominal Diameter	DN	150	150	150	150	150	200	150	150	150	150	150	200	200
Electrical data		400V-3Ph-50Hz												
Nominal power supply		Star-delta start												
Start-up method		24V via internal transformer												
Control power supply		24V via internal transformer												
Nominal unit current draw		24V via internal transformer												
Circuit A+B	A	363	404	383	446	516	546	565	590	658	697	730	537	546
Circuit C	A	-	-	-	-	-	-	-	-	-	-	-	275	273
Maximum unit current draw		24V via internal transformer												
Circuit A+B	A	452	512	479	596	635	734	722	769	830	864	884	678	734
Circuit C	A	-	-	-	-	-	-	-	-	-	-	-	364	367
Maximum start-up current		24V via internal transformer												
Circuit A+B	A	629	782	629	815	905	954	1044	1044	1111	1122	1122	901	954
Circuit C	A	-	-	-	-	-	-	-	-	-	-	-	587	587
Fan and control power	kW	20.0	20.2	22.0	23.0	24.9	26.7	29.8	32.6	34.5	36.0	36.0	30.8	40.3
Unit length	mm	7186	8380	7186	8380	9574	9574	10768	10768	11962	11962	11962	11962	14872
Unit width	mm	2253	2253	2253	2253	2253	2253	2253	2253	2253	2253	2253	2253	2253
Unit height	mm	2297	2297	2297	2297	2297	2297	2297	2297	2297	2297	2297	2297	2297
Unit weight	kg	5916	7331	6002	7749	8487	8723	9108	9188	9723	10344	10344	11831	13156
Operating weight	kg	5994	7430	6080	7870	8620	8870	9252	9332	9867	10500	10500	12060	13400

\* Nominal conditions - evaporator entering/leaving water temperature 12/7°C, outdoor air temperature 35°C  
Evaporator fouling factor 0.018m²K/kW

# Technical Specifications

## Unit with Cu/Al condenser coil

30XQ		0330	0430	0500	0660	0750	0860**	0930**
Nominal Cooling Capacity*	kW	315	414	490	647	735	827	904
Nominal Heating Capacity*	kW	311	407	470	621	706	814	878
Comp. Input Power(cooling)	kW	90.3	118.2	133.7	186.0	210.4	236.3	251.9
Comp. Input Power(heating)	kW	87.9	116.0	135.2	175.7	201.0	231.9	251.2
EER		3.13	3.14	3.25	3.14	3.14	3.13	3.20
COP		3.17	3.14	3.08	3.17	3.14	3.14	3.11
Refrigerant Charge		HFC-134a						
Circuit A	kg	115	160	175	115	160	160	175
Circuit B	kg	-	-	-	115	115	-	-
Circuit C	kg	-	-	-	-	-	160	160
Circuit D	kg	-	-	-	-	-	-	-
Compressor		Semi-hermetic screw compressor						
Circuit A		1	1	1	1	1	1	1
Circuit B		-	-	-	1	1	-	-
Circuit C		-	-	-	-	-	1	1
Circuit D		-	-	-	-	-	-	-
Minimum capacity	%	30	30	30	15	13	15	14
Control		Touch Pilot™ control system, electronic expansion valve (EXV)						
Air heat exchanger		Cu-Al heat exchanger						
Fans		Axial Flying Bird with rotating shroud						
Quantity		6	8	10	12	14	16	18
Total air flow	l/s	27660	36112	45140	54168	63196	72224	81252
Fan speed	rpm	950	950	950	950	950	950	950
Water heat exchanger		Flooded multi-pipe						
Water content	l	70	79	94	119	135	158	173
Nominal flow rate (cooling)	l/s	15.1	19.8	23.4	30.9	35.1	19.8/19.8	19.8/23.4
Nominal flow rate (heating)	l/s	14.9	19.4	22.5	29.7	33.7	19.4/19.4	19.4/22.5
Nominal pressure drop (cooling)	kPa	21.6	23.0	23.3	25.8	42.0	23.0/23.0	23.0/23.3
Nominal pressure drop (heating)	kPa	21.0	22.0	23.1	24.1	40.0	22.0/22.0	22.0/23.1
Max. water-side pressure w/o hydronic module	kPa	1000	1000	1000	1000	1000	1000	1000
Water Connection		Victaulic						
Nominal Diameter	DN	150	150	150	150	150	150/150	150/150
Electrical data		400V-3Ph-50Hz						
Nominal power supply		Star-delta start						
Start-up method		24V via internal transformer						
Control power supply								
Nominal unit current draw, Circuit A+B	A	178	228	271	368	418	228	271
Circuit C+D		-	-	-	-	-	228	228
Maximum unit current draw, Circuit A+B	A	243	341	397	485	583	341	397
Circuit C+D		-	-	-	-	-	341	341
Maximum start-up current, Circuit A+B	A	388	587	587	631	830	587	587
Circuit C+D		-	-	-	-	-	587	587
Fan and control power	kW	10.3	13.7	17.2	20.3	24.0	27.5	30.9
Unit length	mm	3827	4798	5992	7186	8380	9596	10790
Unit width	mm	2253	2253	2253	2253	2253	2253	2253
Unit height	mm	2297	2297	2297	2297	2297	2297	2297
Unit weight	kg	3953	5366	5783	7486	8919	10732	11149
Operating weight	kg	4023	5445	5877	7605	9054	10890	11322

\* Nominal cooling mode - evaporator entering/leaving water temperature 12/7°C, outside air temperature 35°C  
 Nominal heating mode - water heat exchanger entering/leaving water temperature 40/45°C, outside air temperature 7°C  
 Water heat exchanger fouling factor 0.018m²K/kW

\*\* For duplex models (0860-1500) the listed on the left side and right side of "/" refer to module B (circuit C+D) and module A (circuit A+B) respectively



# Technical Specifications

## Unit with Cu/Al condenser coil

30XQ		1000**	1090**	1160**	1250**	1320**	1410**	1500**
Nominal Cooling Capacity*	kW	981	1061	1137	1226	1294	1383	1471
Nominal Heating Capacity*	kW	941	1029	1092	1177	1243	1328	1412
Comp. Input Power(cooling)	kW	267.4	304.1	319.7	344.1	371.9	396.3	420.8
Comp. Input Power(heating)	kW	270.4	291.7	310.9	336.2	351.4	376.7	402.0
EER		3.25	3.14	3.18	3.18	3.14	3.14	3.14
COP		3.09	3.16	3.13	3.12	3.17	3.15	3.14
Refrigerant Charge		HFC-134a						
Circuit A	kg	175	115	115	160	115	160	160
Circuit B	kg	-	115	115	115	115	115	115
Circuit C	kg	175	160	175	175	115	115	160
Circuit D	kg	-	-	-	-	115	115	115
Compressor		Semi-hermetic screw compressor						
Circuit A		1	1	1	1	1	1	1
Circuit B		-	1	1	1	1	1	1
Circuit C		1	1	1	1	1	1	1
Circuit D		-	-	-	-	1	1	1
Minimum capacity	%	15	9	8	8	8	7	7
Control		Touch Pilot™ control system, electronic expansion valve (EXV)						
Air heat exchanger		Cu-Al heat exchanger						
Fans		Axial Flying Bird with rotating shroud						
Quantity		20	20	22	24	24	26	28
Total air flow	l/s	90280	90280	99308	108336	108336	117364	126392
Fan speed	rpm	950	950	950	950	950	950	950
Water heat exchanger		Flooded multi-pipe						
Water content	l	188	198	213	229	238	254	270
Nominal flow rate (cooling)	l/s	23.4/23.4	19.8/30.9	23.4/30.9	23.4/35.1	30.9/30.9	30.9/35.1	35.1/35.1
Nominal flow rate (heating)	l/s	22.5/22.5	19.4/29.7	22.5/29.7	22.5/33.7	29.7/29.7	29.7/33.7	33.7/33.7
Nominal pressure drop (cooling)	kPa	23.3/23.3	23.0/25.8	23.3/25.8	23.3/42.0	25.8/25.8	25.8/42.0	42.0/42.0
Nominal pressure drop (heating)	kPa	23.1/23.1	22.0/24.1	23.1/24.1	23.1/40.0	24.1/24.1	24.1/40.0	40.0/40.0
Max. water-side pressure w/o hydronic module	kPa	1000	1000	1000	1000	1000	1000	1000
Water Connection		Victaulic						
Nominal Diameter	DN	150/150	150/150	150/150	150/150	150/150	150/150	150/150
Electrical data		400V-3Ph-50Hz						
Nominal power supply		Star-delta start						
Start-up method		24V via internal transformer						
Control power supply								
Nominal unit current draw, Circuit A+B	A	271	368	368	418	368	418	418
Circuit C+D		271	228	271	271	368	368	418
Maximum unit current draw, Circuit A+B	A	397	485	485	583	485	583	583
Circuit C+D		397	341	397	397	485	485	583
Maximum start-up current, Circuit A+B	A	587	631	631	830	631	830	830
Circuit C+D		587	587	587	587	631	631	830
Fan and control power	kW	34.4	34.0	37.5	41.2	40.6	44.3	48.0
Unit length	mm	11984	11984	13178	14372	14372	15566	16760
Unit width	mm	2253	2253	2253	2253	2253	2253	2253
Unit height	mm	2297	2297	2297	2297	2297	2297	2297
Unit weight	kg	11566	12852	13269	14702	14972	16405	17838
Operating weight	kg	11754	13050	13482	14931	15210	16659	18108

\* Nominal cooling mode - evaporator entering/leaving water temperature 12/7°C, outside air temperature 35°C  
 Nominal heating mode - water heat exchanger entering/leaving water temperature 40/45°C, outside air temperature 7°C  
 Water heat exchanger fouling factor 0.018m²K/kW

\*\* For duplex models (0860-1500) the listed on the left side and right side of "/" refer to module B (circuit C+D) and module A (circuit A+B) respectively

## Options & accessories

Options	No.	Description	Advantages	Use*
Blygold PoluAL	002B	Coil with factory-applied Blygold PoluAL treatment	Improved corrosion resistance, recommended for heavy marine and industrial environments	30XA0282~0482 30XA0252~1502 30XA0652~1392
Gold Fin	003A	Fin made of pre-treated aluminium (polyurethane and epoxy)	Improved corrosion resistance, recommended for light marine environments	30XA0282~0482 30XA0252~1502 30XA0652~1392
Medium brine	005	Leaving water temperature down to -6 °C	For low temperature applications such as ice storage, cold stores or process cooling etc.	30XA0252~1502
High static fan	012	High static pressure fan for indoor unit installation with discharge ducts	Ducted condenser air discharge, optimized condensing temperature control	30XA0252~1502
Low noise	015	Compressor sound enclosure	Low operating noise	30XA0282~0482 30XA0252~1502 30XA0652~1392
Low noise	015L	Low-speed fan	Low operating noise	30XA0282~0482 30XA0252~1502 30XA0652~1392
Super low noise	015LS	Compressor sound enclosure and low-speed fan	Super low operating noise	30XA0282~0482 30XA0252~1502 30XA0652~1392
Low noise	015S	Compressor and oil separator sound jacket	Low operating noise	30XQ0330~1500
MCHX bare coil	018	Micro-channel heat exchanger	30% reduction of refrigerant charge amount and convenient to clean by a high pressure washer	30XA0282~0482 30XA0252~1502
IP54	020A	IP 54 electrical box protection	Improved electrical box protection, recommended for dusty / sandy environments	30XA0282~0482 30XA0252~1502 30XA0652~1392
Soft starter	025	Electronic starter on each compressor	Reduced start-up current	30XA0602~1502
Winter operation	028	Fan speed control by frequency inverter	Stable operation between -10°C to -20°C outdoor air temperature	30XA0252~1502
Evaporator anti-freeze protection	041A	Electric heater on evaporator	Ensures evaporator anti-freeze protection down to -20°C without glycol	30XA0282~0482 30XA0252~1502
Evaporator and hydronic module anti-freeze protection	041B	Electric heater on evaporator and hydronic module	Ensures evaporator & hydronic module anti-freeze protection down to -20°C without glycol	30XA0282~0482 30XA0252~0502
Full heat recovery	050	Heat recovery water cooled condenser	Recover 100% of rejected heat	30XA0252~1002
Single point power connection	081	Single main power connection	Easy to power connection	30XA1352/1502

\* 30XA0282~0482 - 30XA0282/0342/0442/0482  
 30XA0252~0502 - 30XA0252/0302/0352/0402/0452/0502  
 30XA0252~1002 - 30XA0252/0302/0352/0402/0452/0502/0602/0702/0752/0852/0902/1002  
 30XA0252~1502 - 30XA0252/0302/0352/0402/0452/0502/0602/0702/0752/0852/0902/1002/1352/1502  
 30XA0602~1502 - 30XA0602/0702/0752/0852/0902/1002/1352/1502  
 30XA0652~1392 - 30XA0652/0712/0762/1052/1152/1252/1312/1392  
 30XQ0330~1500 - 30XQ0330/0430/0500/0660/0750/0860/0930/1000/1090/1160/1250/1320/1410/1500

## Options & accessories

Options	No.	Description	Advantages	Use*
1600kPa evaporator	104	Reinforced evaporator for extension of the maximum water-side pressure range to 1600kPa	Covers applications with a high water column (high buildings)	30XA0282~0482 30XA0252~1502
Reversed water connections	107	Evaporator with reversed water inlet/outlet	Simplification of water piping	30XA0282~0482 30XA0602~1502 30XA0712/0762
Fixed speed single pump hydronic module	116B	Provide fixed speed single pump of average 200KPa external pressure	Easy and fast installation	30XA0252~0502
Fixed speed dual pump hydronic module	116C	Provide fixed speed dual pumps of average 200KPa external pressure	Easy and fast installation, operating safety	30XA0282~0482 30XA0252~0502
Direct-expansion free-cooling system	118A	Chilled water production without the use of the compressors, using direct-expansion heat exchange on the condensers	Very economical chilled water production at low outdoor temperatures	30XA0252-1002**
J-Bus gateway	148B	Two-directional communication board with J-Bus protocol	Easy connection by communication bus to a building management system	30XA0282~0482 30XA0252~1502 30XA0652~1392 30XQ0330~1500
BacNet gateway	148C	Two-directional communication board with BacNet protocol	Easy connection by communication bus to a building management system	30XA0282~0482 30XA0252~1502 30XA0652~1392 30XQ0330~1500
LonTalk gateway	148D	Two-directional communication board with LonTalk protocol	Easy connection by communication bus to a building management system	30XA0282~0482 30XA0252~1502 30XA0652~1392 30XQ0330~1500
Energy Management Module (EMM)	156	See control manual	-	30XA0282~0482 30XA0252~1502 30XA0652~1392 30XQ0330~1500
Touch screen display	158	Pro-Dialog control with touch screen interface	User friendly	30XA0282~0482 30XA0252~1502 30XA0652~1392 30XQ0330~1500
Cu/Al condenser coils	254	Coil made of copper tube with aluminium fin	-	30XA0282~0482 30XA0252~1502 30XA0652~1392
Super Enviro-shield MCHX coils	263	E-coated MCHX coils	Improved corrosion resistance, recommended for heavy marine and industrial environments	30XA0282~0482 30XA0252~1502
38mm cooler insulation	299	38mm thermal insulation on cooler	Better prevents condensation on high humidity environment	30XA0252-1502
Lead Lag Control	301	To allow master/slave operation of two chillers connected in parallel or series	Optimised operation of two chillers connected in parallel with operating time balancing	30XA0252-1502
Blue fin	303	Hydrophilic aluminium foil	Enhanced hydrophilic character and better aesthetics	30XA0282~0482 30XA0252~1502
Conformance with Australian regulations	312AN	Evaporator and oil separator modified according to Australian regulations	-	30XA0282~0482 30XA0252~1502

\* 30XA0282~0482 - 30XA0282/0342/0442/0482  
 30XA0252~0502 - 30XA0252/0302/0352/0402/0452/0502  
 30XA0252~1502 - 30XA0252/0302/0352/0402/0452/0502/0602/0702/0752/0852/0902/1002/1352/1502  
 30XA0602~1502 - 30XA0602/0702/0752/0852/0902/1002/1352/1502  
 30XA0652~1392 - 30XA0652/0712/0762/1052/1152/1252/1312/1392  
 30XQ0330~1500 - 30XQ0330/0430/0500/0660/0750/0860/0930/1000/1090/1160/1250/1320/1410/1500

\*\* 30XA0252~1002 - 30XA0252/0302/0402/0452/0502/0602/0702/0852/1002 (for both MCHX coil & Cu-Al Coil)  
 30XA0352/0752/0902 only for MCHX coil



## Dimensions/Clearances

### 30XA0282~0482 - Cu/Al Condenser coils (option 254)

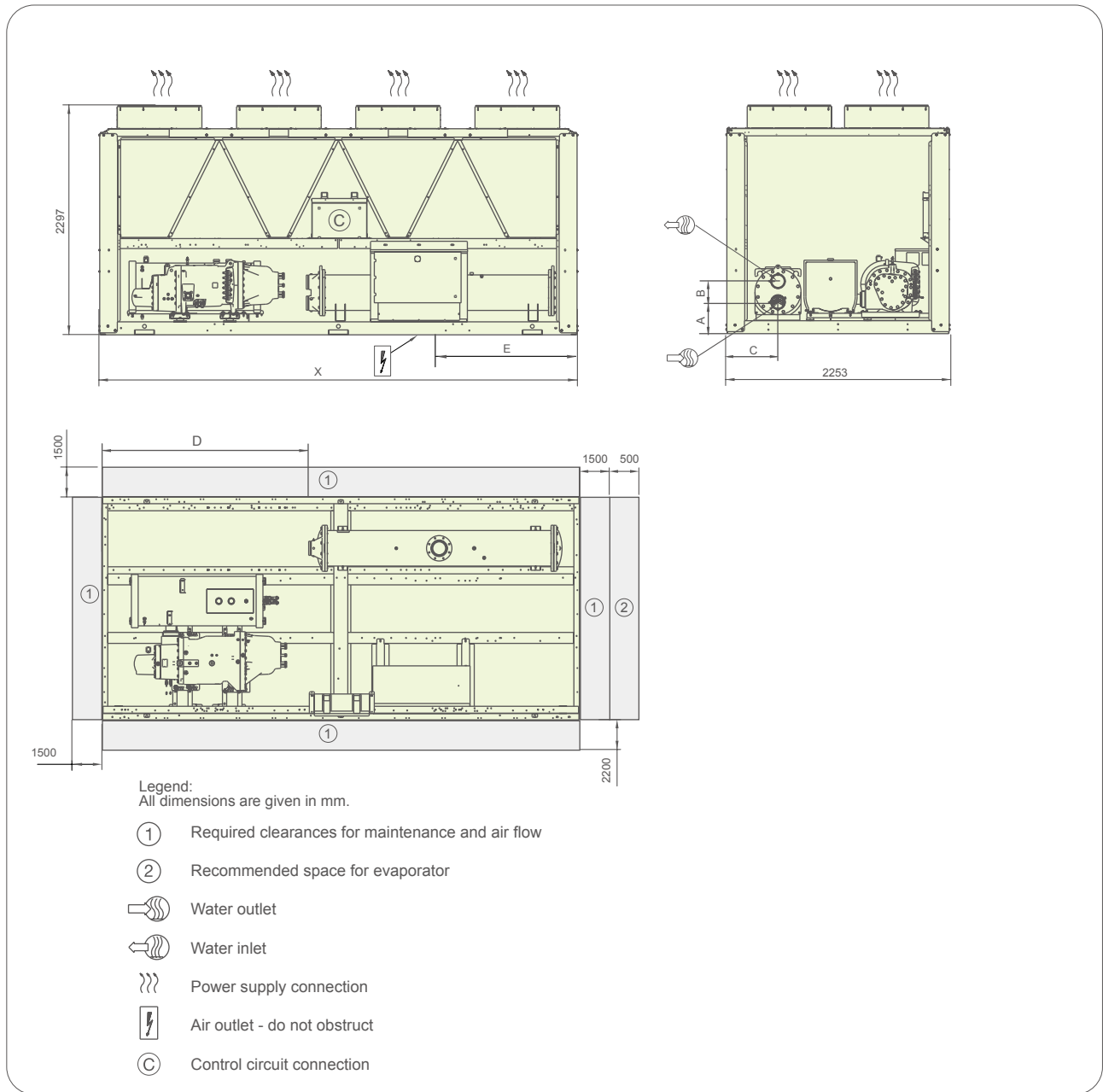

30XA	A	B	C	D	E	X
0282	317	210	515	1371	734	3604
0342	317	210	515	1371	1371	3604
0442	346	272	438	2182	1371	4798
0482	346	272	438	2182	1371	4798

Note: Single point power connection, power cable arrive from bottom of electrical box, reserve at least 120mm height space below unit for power supply connection (unit aerial installation or cable slot)

## Dimensions/Clearances

### 30XA0252/0302 - Cu/Al Condenser coils (option 254)

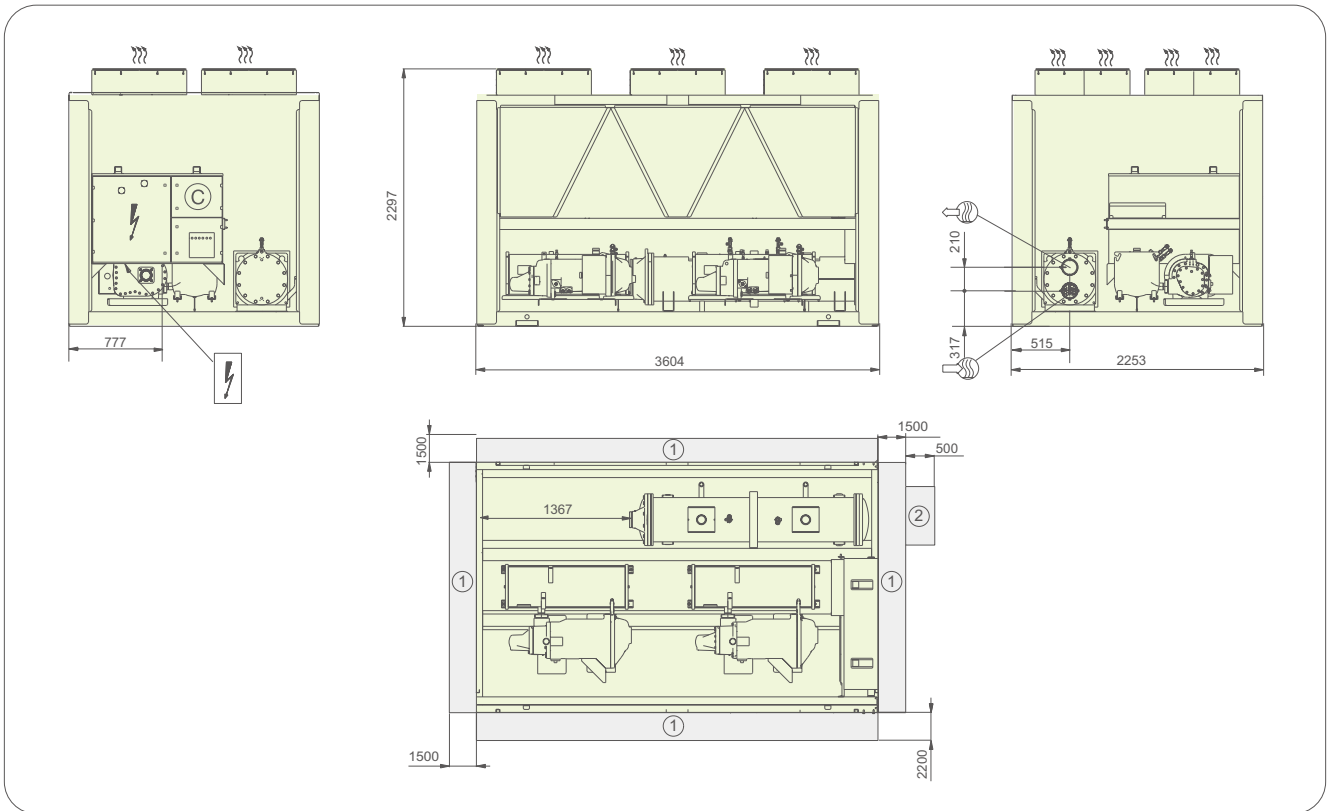

### 30XA0352/0402/0452 - Cu/Al Condenser coils (option 254)

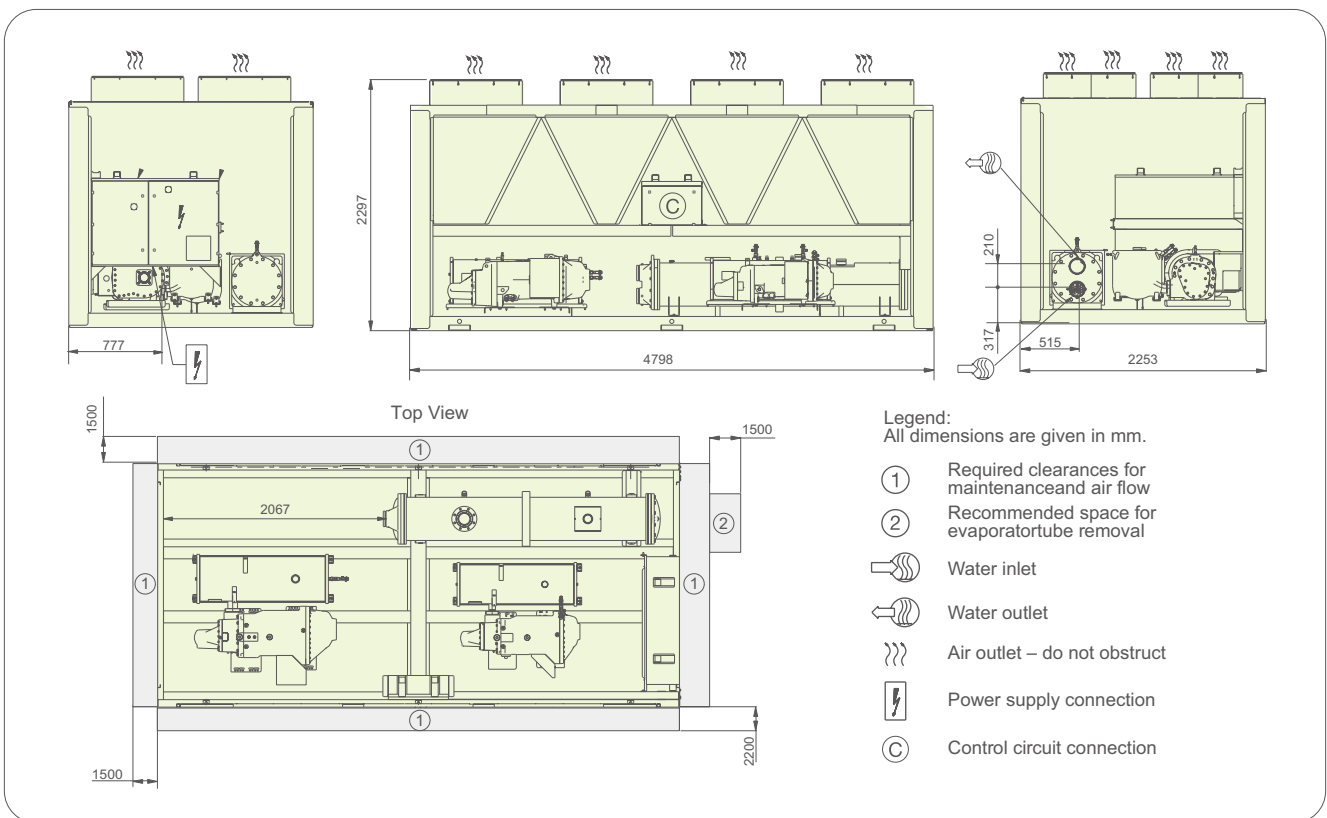

Note: Single point power connection, power cable arrive from bottom of electrical box

## Dimensions/Clearances

### 30XA0502 - Cu/Al Condenser coils (option 254)

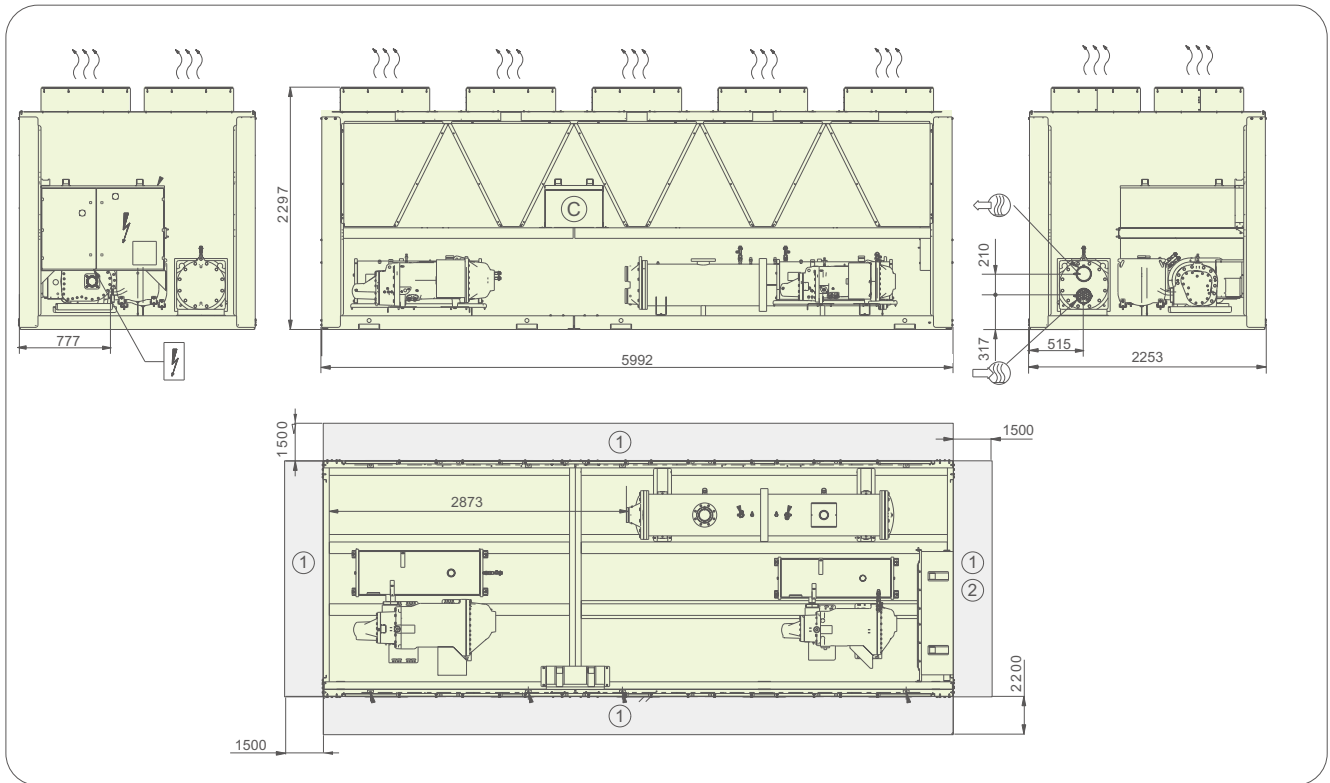

### 30XA 0602/0702 - Cu/Al Condenser coils (option 254)

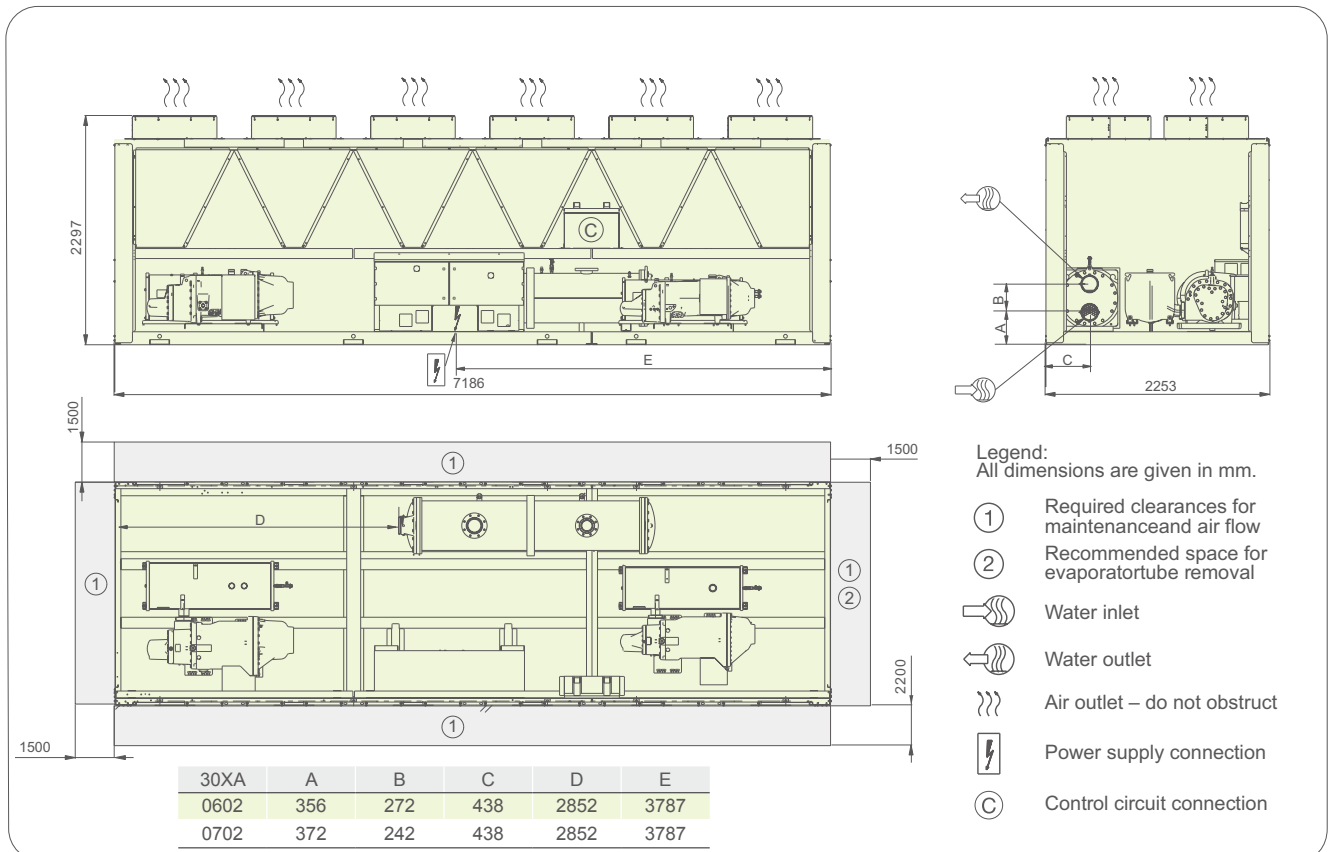

Note: Single point power connection, power cable arrive from bottom of electrical box, reserve at least 120mm height space below unit for 30XA0602~0702 power supply connection (unit aerial installation or cable slot)

## Dimensions/Clearances

### 30XA0652 - Cu/Al Condenser coils (option 254)

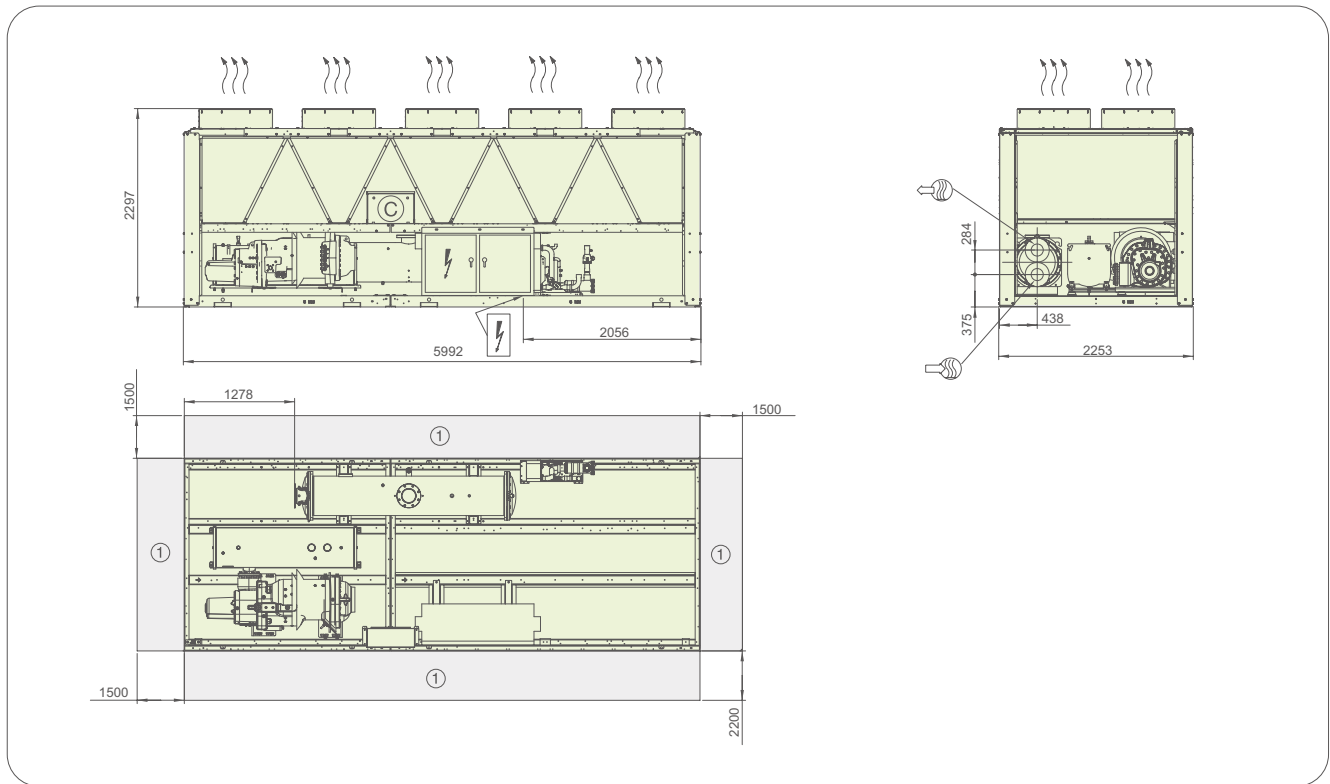

### 30XA0712/0762 - Cu/Al Condenser coils (option 254)

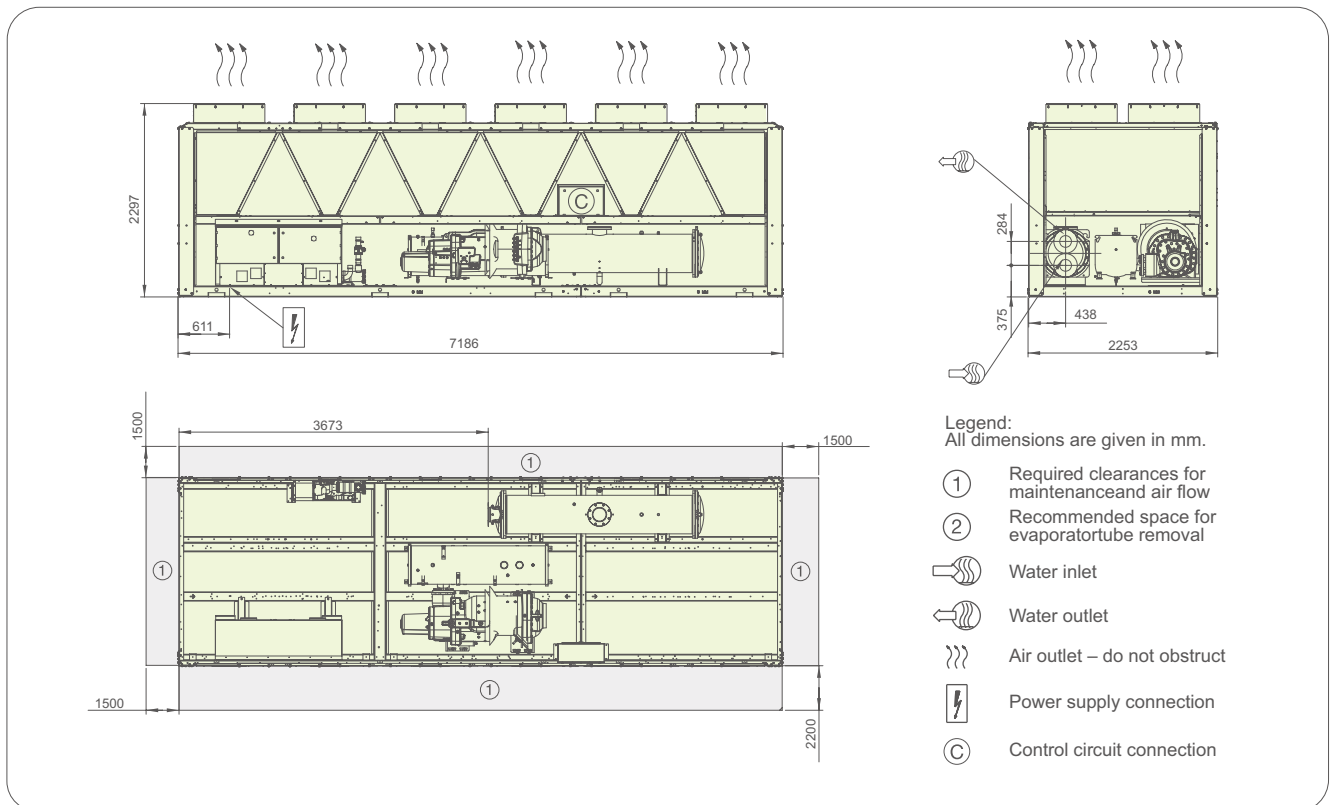

Note: Single point power connection, power cable arrive from bottom of electrical box, reserve at least 120mm height space below unit for 30XA0652~0762 power supply connection (unit aerial installation or cable slot)

# Dimensions/Clearances

## 30XA0752/0852 - Cu/Al Condenser coils (option 254)

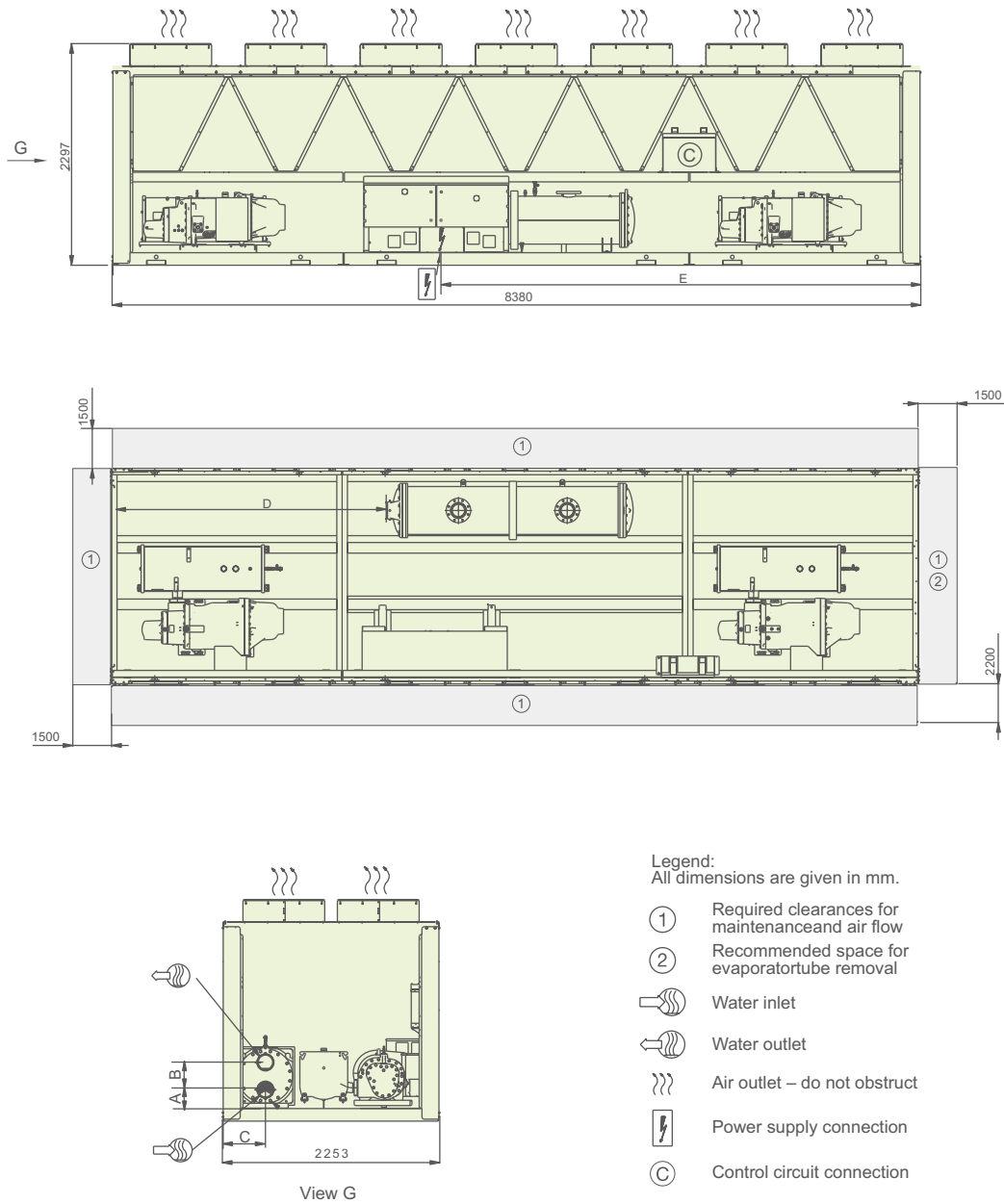

30XA	A	B	C	D	E
0752	372	242	438	2848	4965
0852	325	284	438	2836	4965

Note: Single point power connection, power cable arrive from bottom of electrical box, reserve at least 120mm height space below unit for power supply connection (unit aerial installation or cable slot)

# Dimensions/Clearances

## 30XA0902/1002 - Cu/Al Condenser coils (option 254)

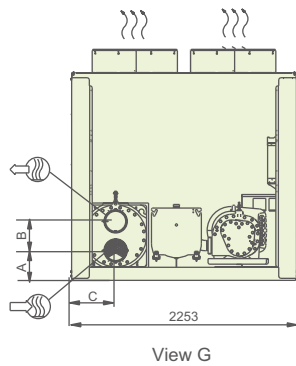
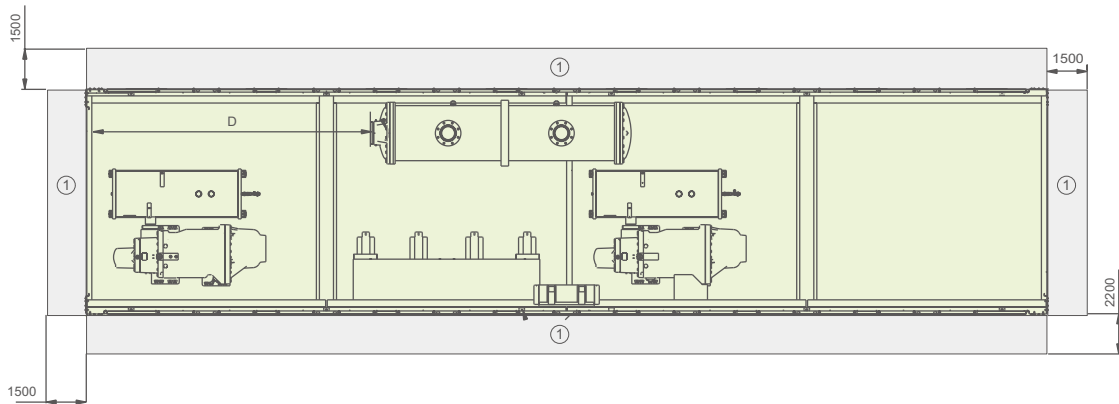
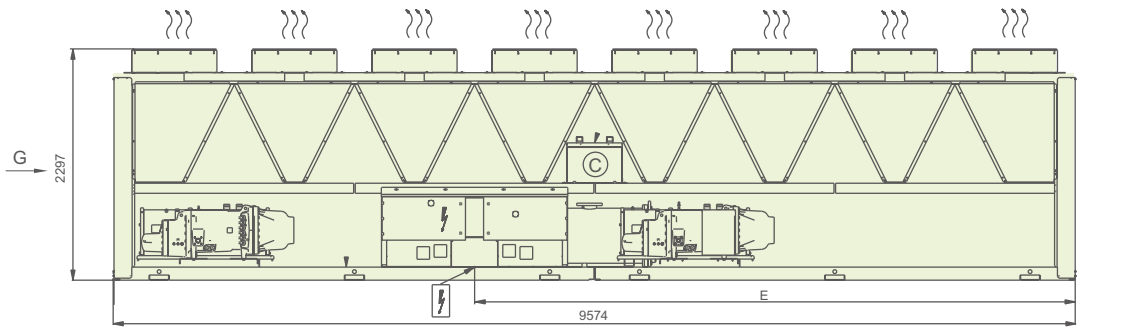

Legend:  
All dimensions are given in mm.

- ① Required clearances for maintenance and air flow
- ② Recommended space for evaporator tube removal
- Water inlet
- Water outlet
- Air outlet – do not obstruct
- Power supply connection
- Ⓢ Control circuit connection

30XA	A	B	C	D	E
0902	325	284	438	2840	5924
1002	297	438	438	2832	5924

Note: Single point power connection, power cable arrive from bottom of electrical box, reserve at least 120mm height space below unit for power supply connection (unit aerial installation or cable slot)



# Dimensions/Clearances

## 30XA1052/1152 - Cu/Al Condenser coils (option 254)

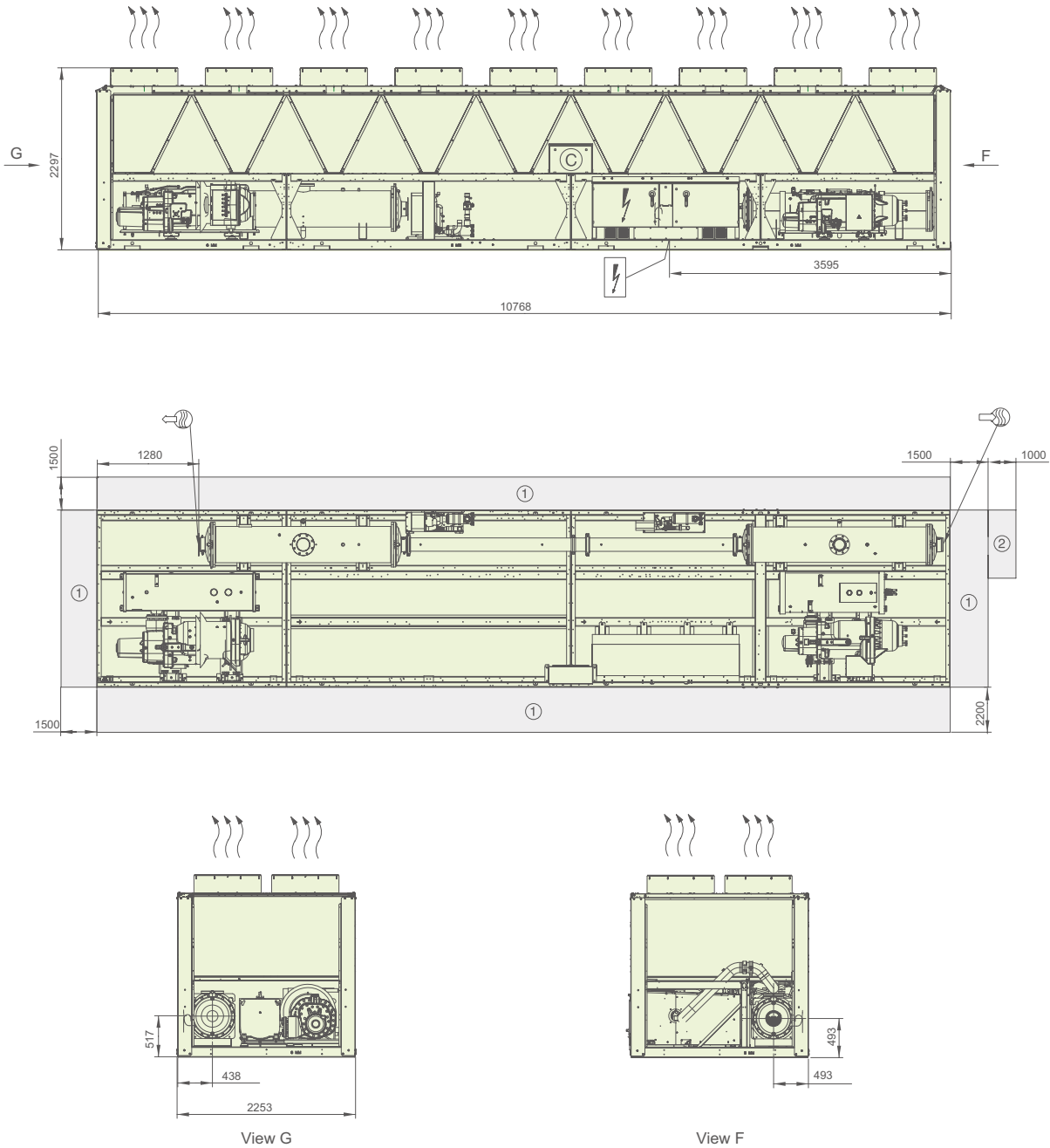

Legend:  
 All dimensions are given in mm.  
 ① Required clearances for maintenance and air flow  
 ② Recommended space for evaporator tube removal

Water inlet  
 Water outlet

))) Air outlet – do not obstruct  
 Power supply connection  
 C Control circuit connection

Note: Single point power connection, power cable arrive from bottom of electrical box, reserve at least 120mm height space below unit for 30XA1052/1152 power supply connection (unit aerial installation or cable slot)

# Dimensions/Clearances

## 30XA1252 - Cu/Al Condenser coils (option 254)

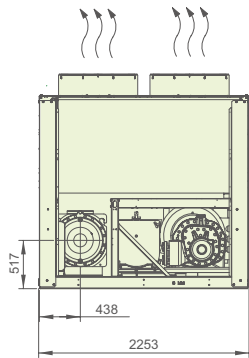
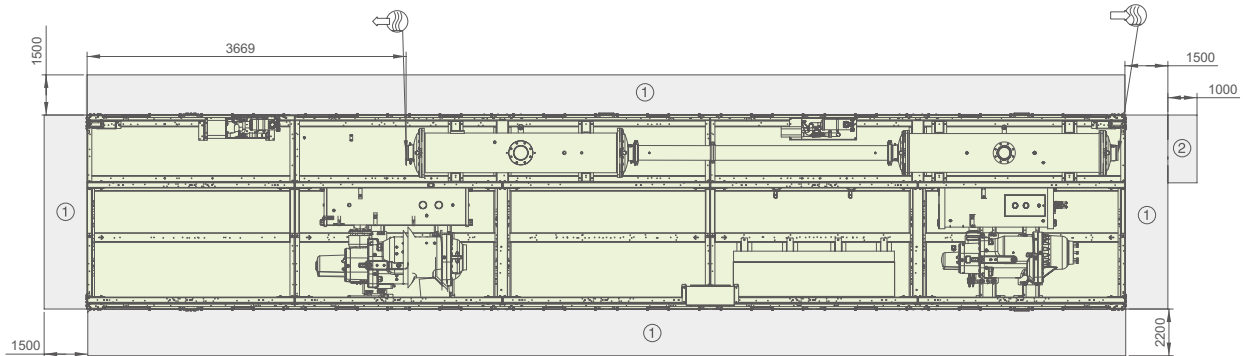
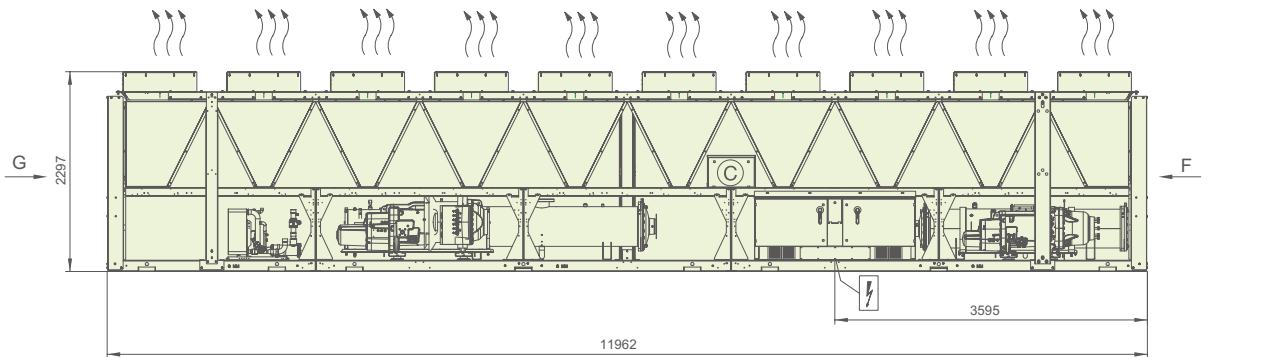

View G

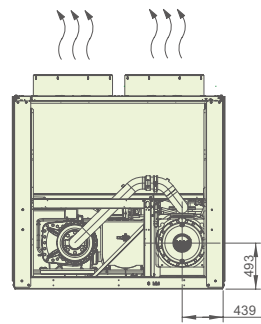

View F

**Legend:**

All dimensions are given in mm.

- ① Required clearances for maintenance and air flow
- ② Recommended space for evaporator tube removal

- Water inlet
- Water outlet

- Air outlet – do not obstruct
- Power supply connection
- Control circuit connection

Note: Single point power connection, power cable arrive from bottom of electrical box, reserve at least 120mm height space below unit for 30XA1052/1152 power supply connection (unit aerial installation or cable slot)

## Dimensions/Clearances

### 30XA1312/1392 - Cu/Al Condenser coils (option 254)

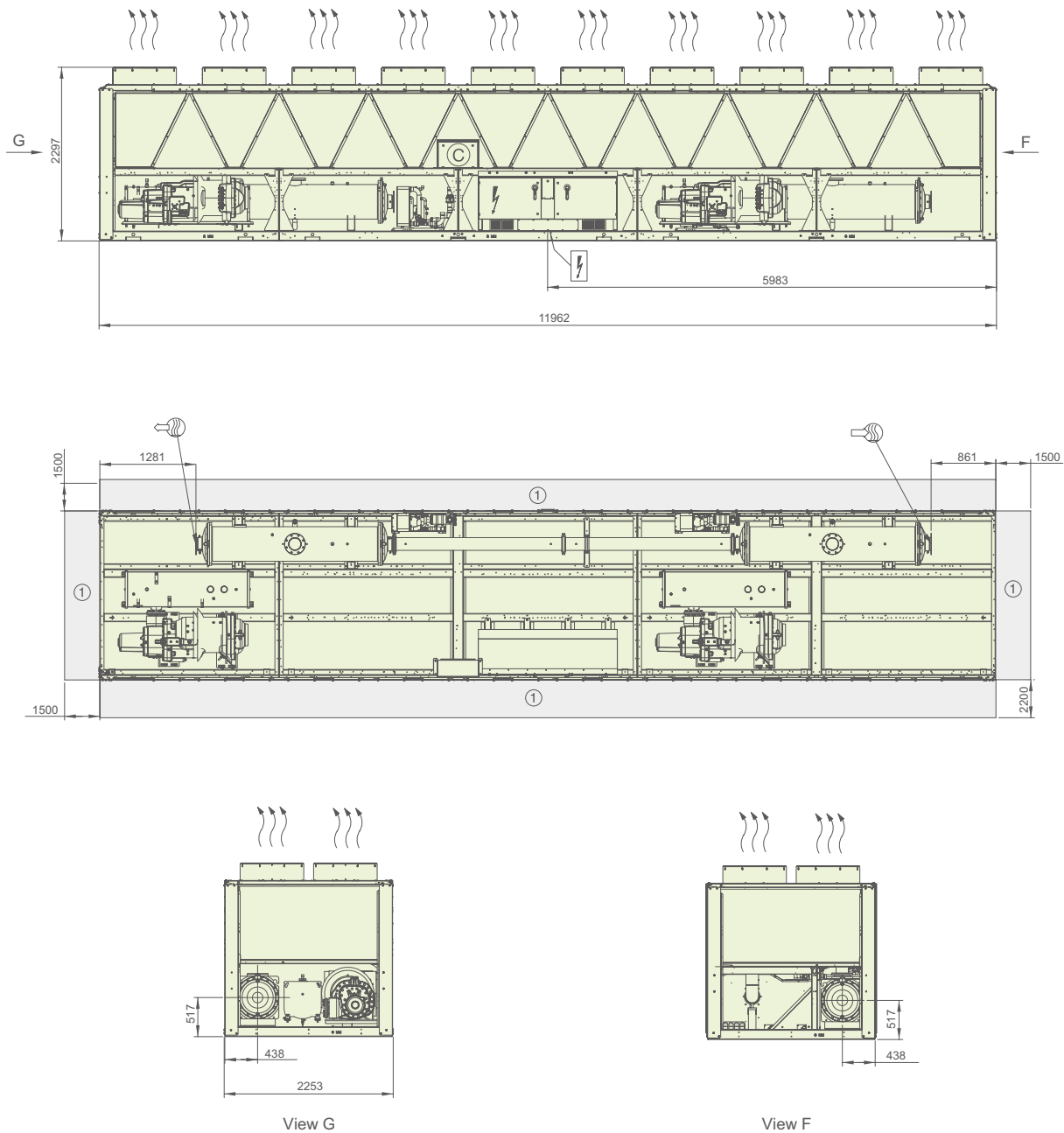

**Legend:**

All dimensions are given in mm.

- ① Required clearances for maintenance and air flow
- ② Recommended space for evaporator tube removal

- Water inlet
- Water outlet

- Air outlet – do not obstruct
- Power supply connection
- Control circuit connection

Note: Single point power connection, power cable arrive from bottom of electrical box, reserve at least 120mm height space below unit for 30XA1312/1392 power supply connection (unit aerial installation or cable slot)

# Dimensions/Clearances

## 30XA1352 - Cu/Al Condenser coils (option 254)

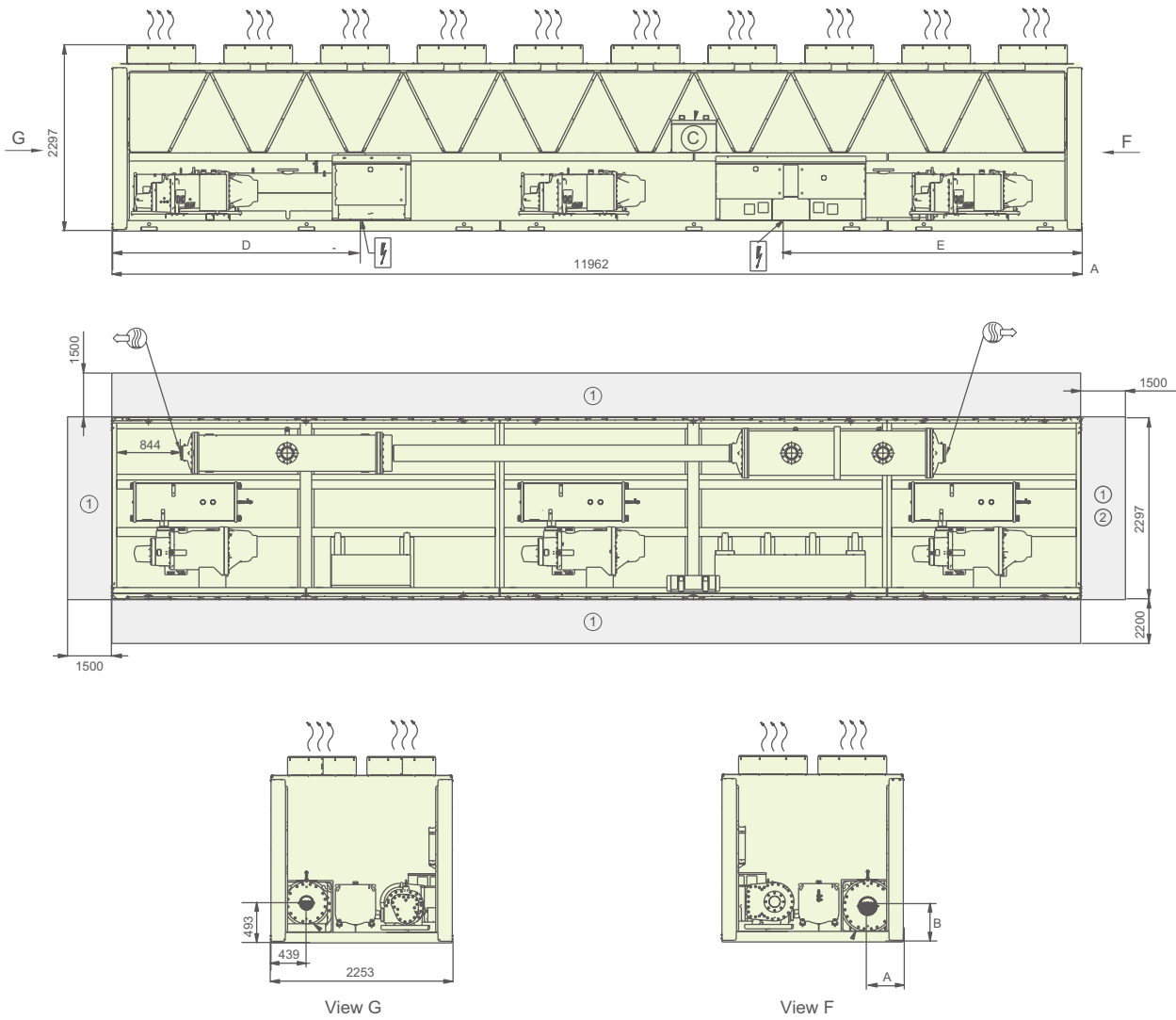

- Legend:  
All dimensions are given in mm.
- ① Required clearances for maintenance and air flow
  - ② Recommended space for evaporator tube removal

- Water inlet
- Water outlet
- Air outlet – do not obstruct
- Power supply connection
- Control circuit connection

30XA	A	B	C	D	E
1352	439	442	1670	3428	3387

Note: Dual point power connection (Single point power connection as option), power cable arrive from bottom of electrical box, reserve at least 120mm height space below unit for power supply connection (unit aerial installation or cable slot)

# Dimensions/Clearances

## 30XA1502, module 1/2 - Cu/Al Condenser coils (option 254)

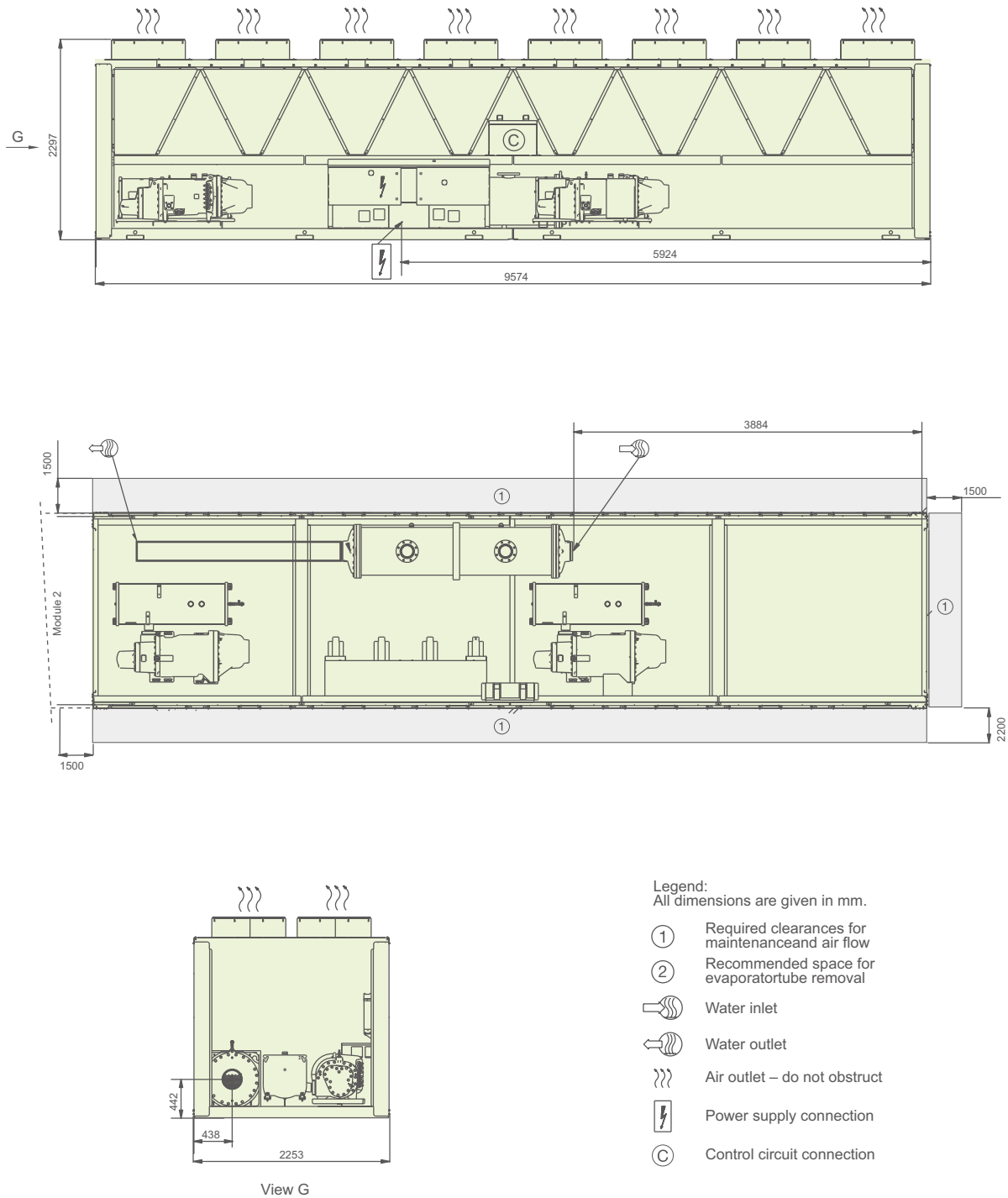

Note: Dual point power connection (Single point power connection as option), power cable arrive from bottom of electrical box, reserve at least 120mm height space below unit for power supply connection (unit aerial installation or cable slot)

## Dimensions/Clearances

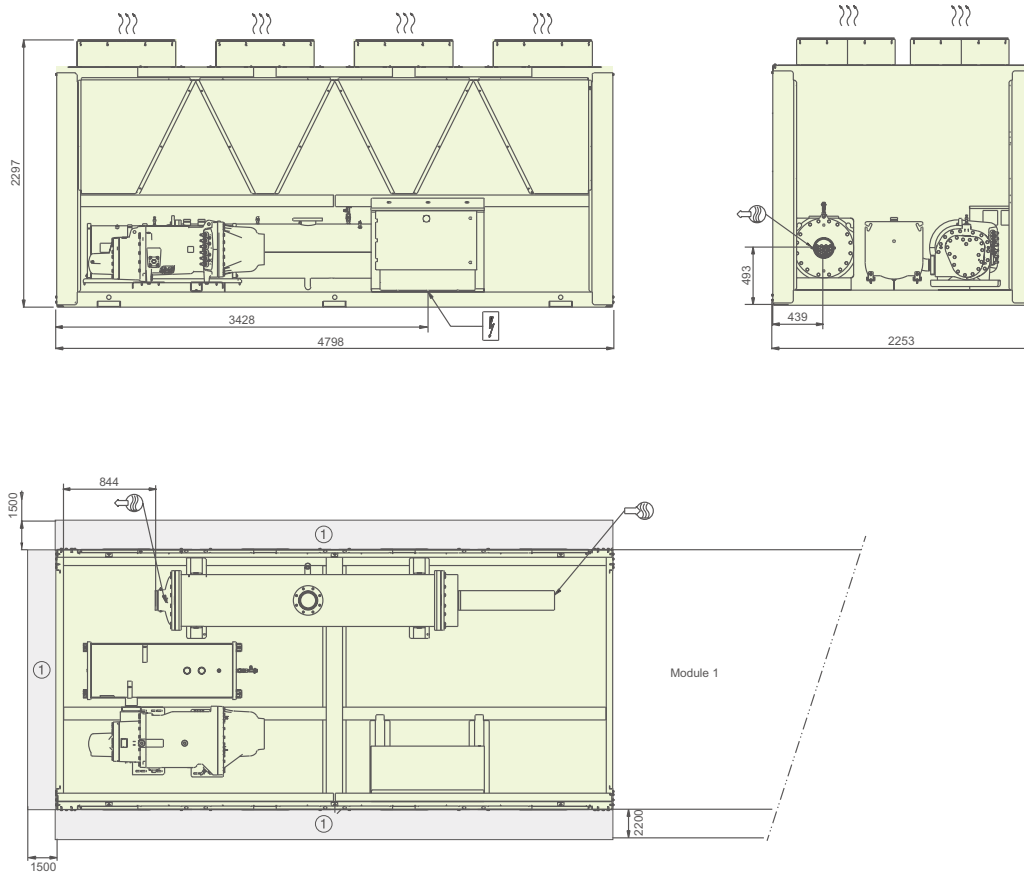

### 30XA1502, module 2/2 - Cu/Al Condenser coils (option 254)





**Legend:**

All dimensions are given in mm.

- ① Required clearances for maintenance and air flow
- ② Recommended space for evaporator tube removal

-  Water inlet
-  Water outlet

-  Air outlet – do not obstruct
-  Power supply connection
- ⓐ Control circuit connection

Note: Dual point power connection (Single point power connection as option), power cable arrive from bottom of electrical box, reserve at least 120mm height space below unit for power supply connection (unit aerial installation or cable slot)



## Dimensions/Clearances

### 30XQ0300 - Cu/Al Condenser coils

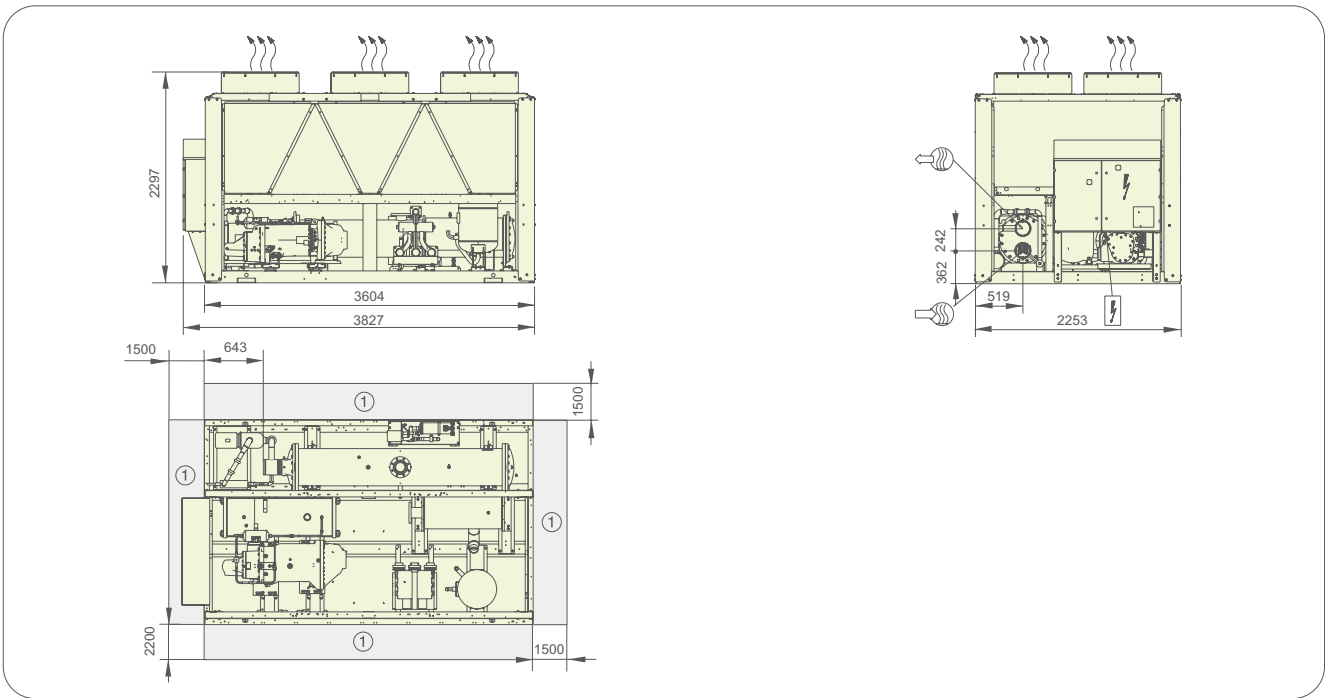

### 30XQ0430/0500 - Cu/Al Condenser coils

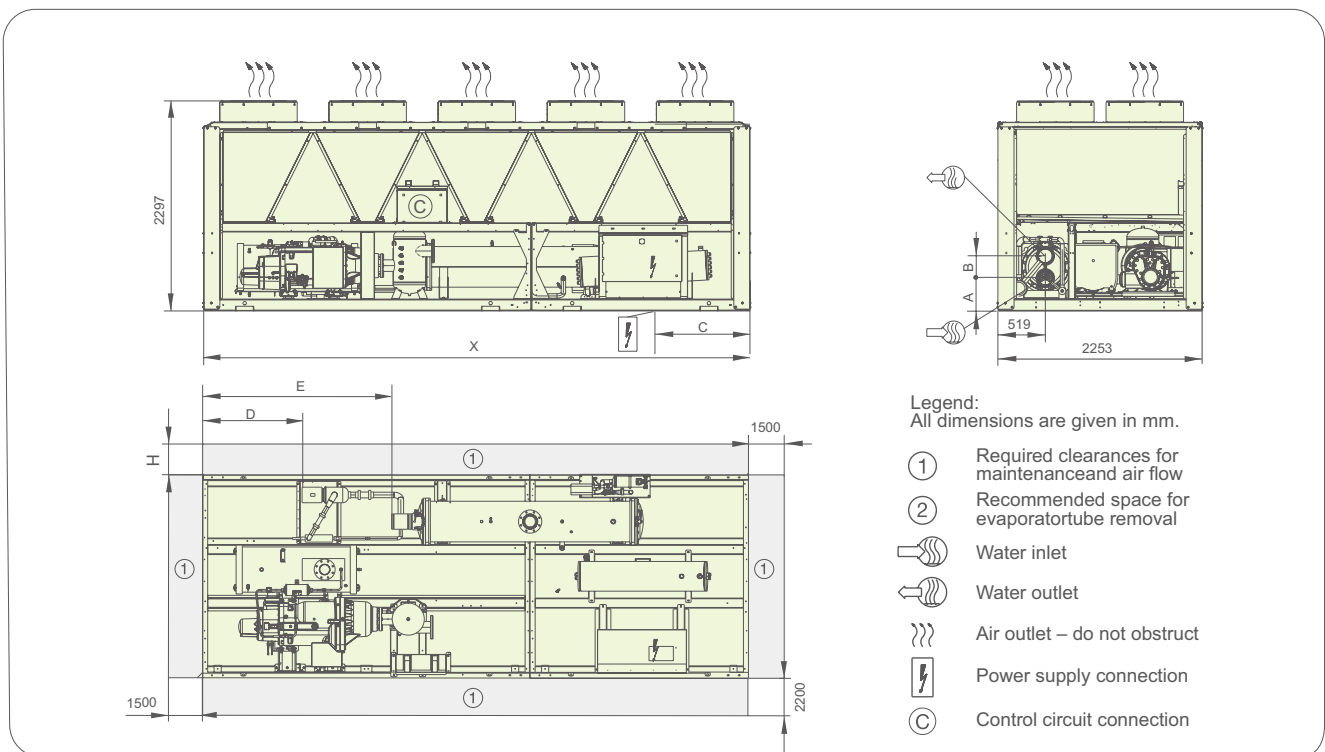

30XQ	A	B	C	D	E	H	X
0430	362	242	457	856	1854	1500	4798
0500	362	242	950	856	1854	1500	5992

Note: Single point power connection, power cable arrive from bottom of electrical box, reserve at least 120mm height space below unit for 30XQ0430~0500 power supply connection (unit aerial installation or cable slot)

# Dimensions/Clearances

## 30XQ0660/0750 - Cu/Al Condenser coils

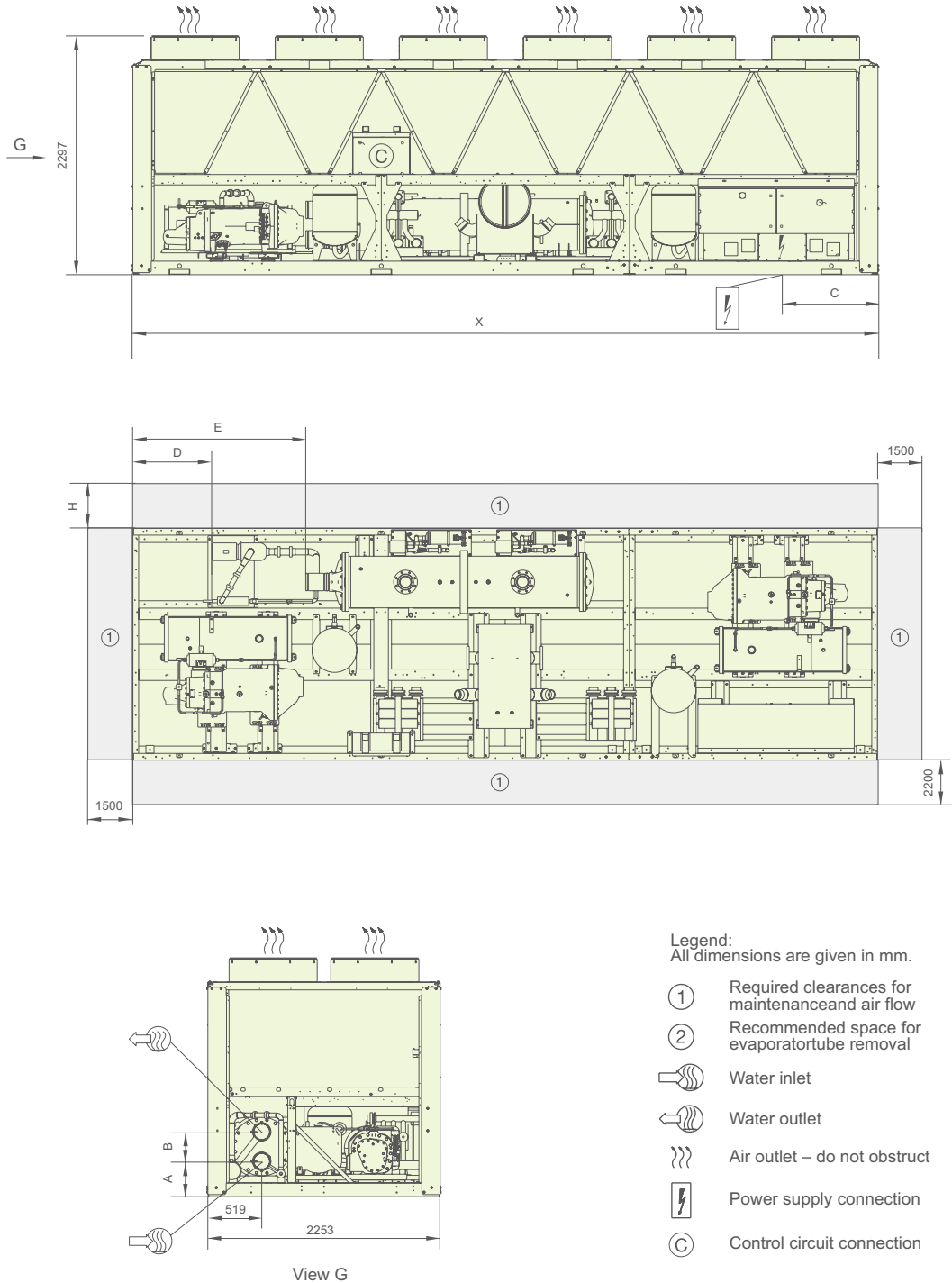

30XQ	A	B	C	D	E	H	X
0660	340	284	943	762	1663	2200	7186
0750	340	284	4730	1396	2297	1500	8380

Note: Single point power connection, power cable arrive from bottom of electrical box, reserve at least 120mm height space below unit for power supply connection (unit aerial installation or cable slot)

# Dimensions/Clearances

## 30XQ0860~1500 - Cu/Al Condenser coils

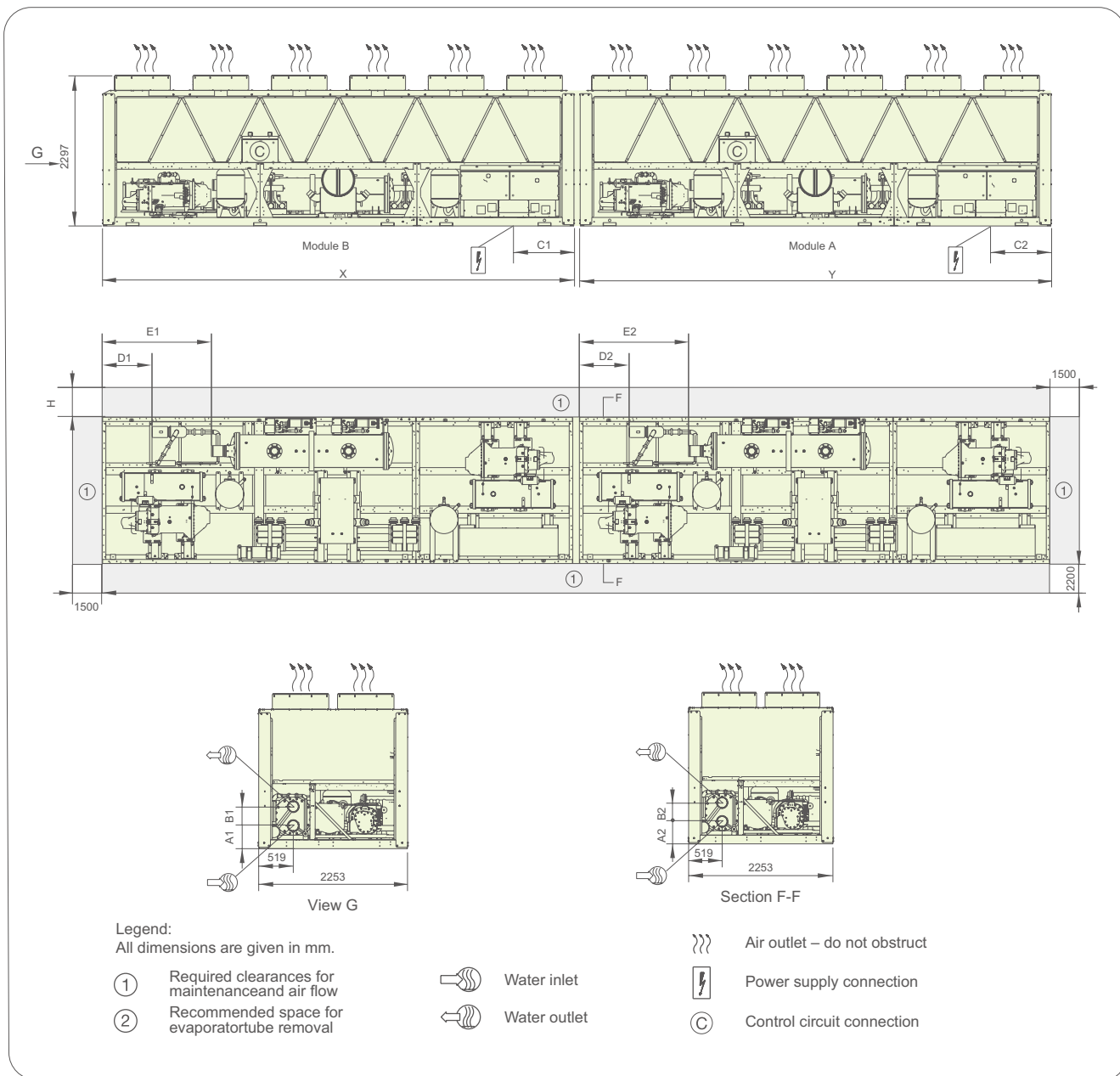

30XQ	A1	A2	B1	B2	C1	C2	D1	D2	E1	E2	H	X	Y
0860	362	362	242	242	457	457	856	856	1854	1854	1500	4798	4798
0930	362	362	242	242	457	950	856	856	1854	1854	1500	4798	5992
1000	362	362	242	242	950	950	856	856	1854	1854	1500	5992	5992
1090	362	340	242	284	457	943	856	762	1854	1663	2200	4798	7186
1160	362	340	242	284	950	943	856	762	1854	1663	2200	5992	7186
1250	362	340	242	284	950	4730	856	1396	1854	2297	1500	5992	8380
1320	340	340	284	284	943	943	762	762	1663	1663	2200	7186	7186
1410	340	340	284	284	943	4730	762	1396	1663	2297	2200	7186	8380
1500	340	340	284	284	4730	4730	1396	1396	2297	2297	1500	8380	8380

Note: Dual point power connection, power cable arrive from bottom of electrical box, reserve at least 120mm height space below unit for power supply connection (unit aerial installation or cable slot)

# Multiple Chiller Installation

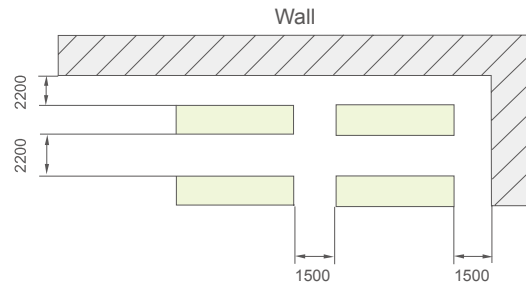
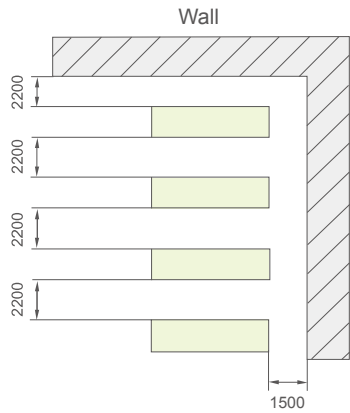

Note: If the height of wall exceeds 2m, please contact local Carrier Sales & Service Corporation.

# Weight Distribution, 30XA0252~1502

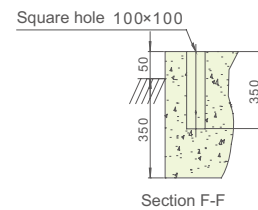
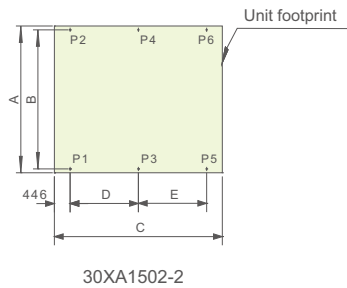
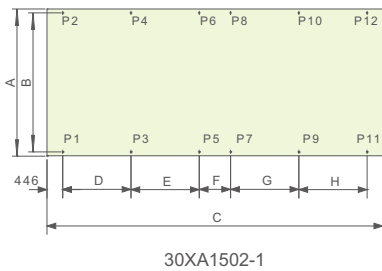
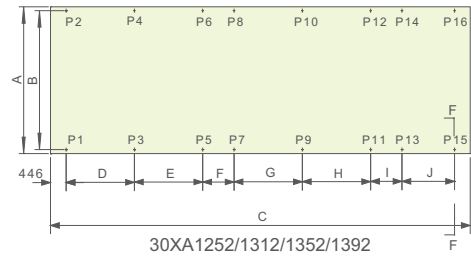
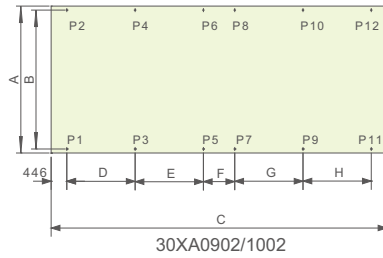
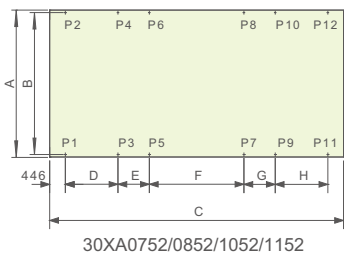
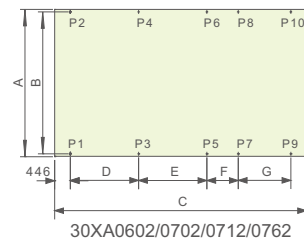
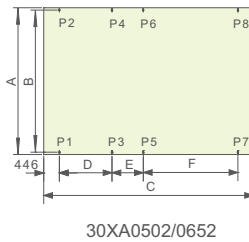
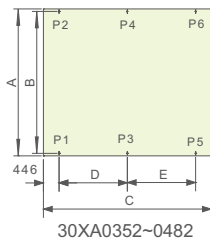
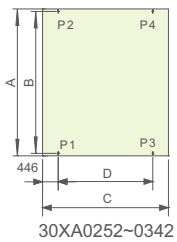

## Weight Distribution, 30XA0252~1502

Models	Dimensions, mm										Weight distribution, kg																Operating weight kg	
	A	B	C	D	E	F	G	H	I	J	P1	P2	P3	P4	P5	P6	P7	P8	P9	P10	P11	P12	P13	P14	P15	P16		
30XA0252	2231	2157	3582	2690							930	901	1016	983														3830
30XA0282	2231	2157	3582	2690							865	775	1015	923														3578
30XA0302	2231	2157	3582	2690							942	835	1103	980														3860
30XA0342	2231	2157	3582	2690							930	840	1100	1005														3875
30XA0352	2231	2157	4776	1942	1942						737	665	768	692	798	720												4380
30XA0402	2231	2157	4776	1942	1942						859	739	865	745	871	751												4830
30XA0442	2231	2157	4776	1942	1942						991	887	784	701	665	612												4640
30XA0452	2231	2157	4776	1942	1942						876	751	880	753	884	756												4900
30XA0482	2231	2157	4776	1942	1942						1080	976	874	790	663	601												4984
30XA0502	2231	2157	5970	1496	892	2690					716	628	724	635	730	639	744	654										5470
30XA0602	2231	2157	7164	1942	1942	892	1496				698	601	697	599	697	599	697	599	695	598								6480
30XA0652	2231	2157	5970	1496	892	2690					915	739	796	643	725	586	511	413										5328
30XA0702	2231	2157	7164	1942	1942	892	1496				709	615	709	618	710	618	711	618	713	619								6640
30XA0712	2231	2157	7164	1942	1942	892	1496				599	526	622	546	645	565	655	575	672	589								5994
30XA0752	2231	2157	8358	1496	892	2690	892	1496			704	600	691	588	682	580	656	558	647	552	633	539						7430
30XA0762	2231	2157	7164	1942	1942	892	1496				591	542	616	565	641	588	652	598	671	616								6080
30XA0852	2231	2157	8358	1496	892	2690	892	1496			739	644	724	631	716	622	687	598	678	591	662	578						7870
30XA0902	2231	2157	9552	1942	1942	892	1942	1942			865	764	820	723	773	683	752	664	707	624	661	584						8620
30XA1002	2231	2157	9552	1942	1942	892	1942	1942			899	793	847	749	796	704	772	683	722	639	671	595						8870
30XA1052	2231	2157	10746	1496	892	2690	2834	1942			846	711	844	709	842	708	837	703	831	699	827	695						9252
30XA1152	2231	2157	10746	1496	892	2690	2834	1942			862	707	858	705	857	704	853	701	848	697	845	695						9332
30XA1252	2231	2157	11940	1496	892	1942	1942	892	1942	1942	605	541	618	553	626	560	643	575	661	590	668	597	686	613	703	628		9867
30XA1312	2231	2157	11940	1496	892	1942	1942	892	1942	1942	800	626	782	612	771	601	747	585	724	566	713	558	689	539	666	521		10500
30XA1352	2231	2157	11940	1942	1942	892	1942	1942	892	1496	792	711	793	712	794	712	796	713	794	713	797	713	796	714	796	714		12060
30XA1392	2231	2157	11940	1496	892	1942	1942	892	1942	1942	800	626	782	612	771	601	747	585	724	566	713	558	689	539	666	521		10500
30XA1502/1	2231	2157	9552	1942	1942	892	1942	1942			906	802	853	754	803	709	780	688	727	642	676	599						8939
30XA1502/2	2231	2157	4776	1942	1942						981	877	785	701	590	527												4461

Note: (1) foot screw even hole number (far side) represent for evaporator side  
 (2) foot screw, M20X300

# Weight Distribution, 30XQ0330~1500

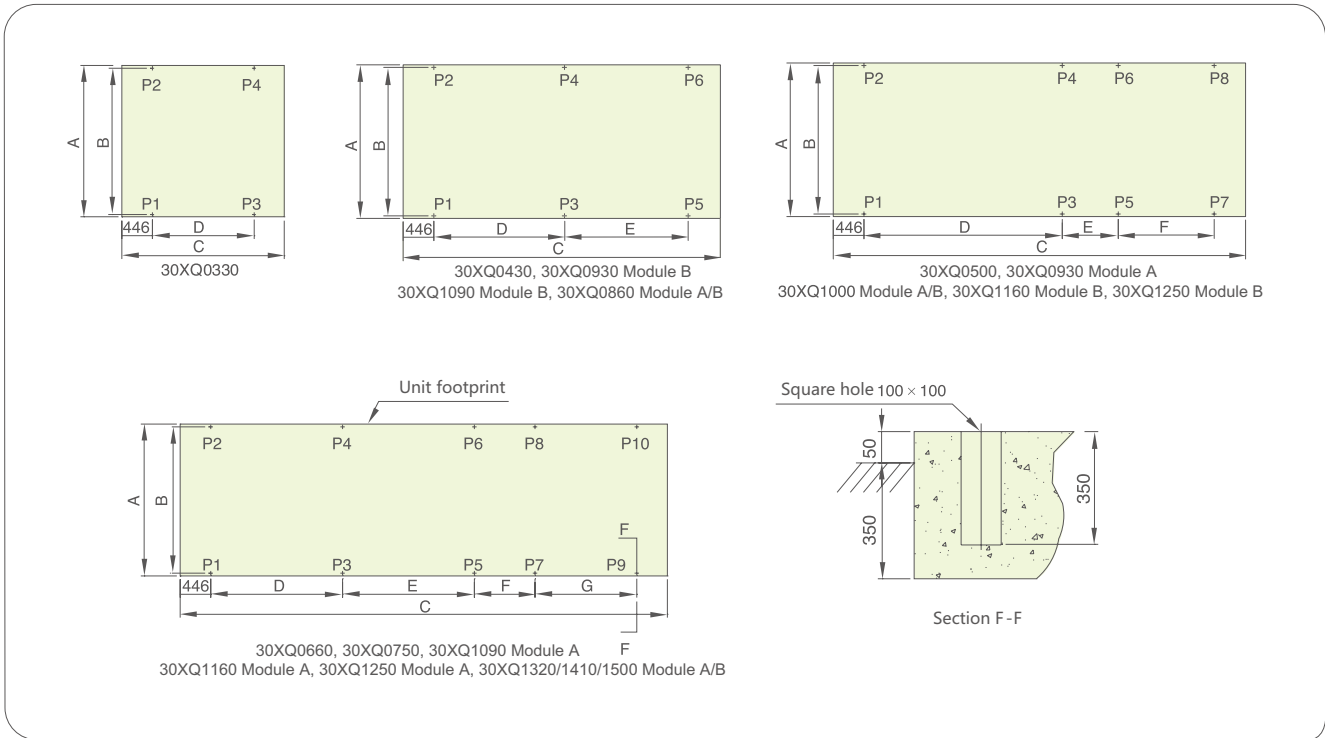

Models	Dimensions, mm							Weight distribution, kg										Operating weight kg
	A	B	C	D	E	F	G	P1	P2	P3	P4	P5	P6	P7	P8	P9	P10	
30XQ0330	2231	2157	3582	2690				1398	1273	708	644							4023
30XQ0430	2231	2157	4476	1942	1942			962	908	934	881	906	854					5445
30XQ0860 Module A/B	2231	2157	4476	1942	1942			962	908	934	881	906	854					5445
30XQ0930 Module B	2231	2157	4476	1942	1942			962	908	934	881	906	854					5445
30XQ1090 Module B	2231	2157	4476	1942	1942			962	908	934	881	906	854					5445
30XQ0500	2231	2157	5970	2690	892	1496		914	856	767	718	718	672	636	596			5877
30XQ0930 Module A	2231	2157	5970	2690	892	1496		914	856	767	718	718	672	636	596			5877
30XQ1000 Module A/B	2231	2157	5970	2690	892	1496		914	856	767	718	718	672	636	596			5877
30XQ1160 Module B	2231	2157	5970	2690	892	1496		914	856	767	718	718	672	636	596			5877
30XQ1250 Module B	2231	2157	5970	2690	892	1496		914	856	767	718	718	672	636	596			5877
30XQ0660	2231	2157	7164	1942	1942	892	1496	739	727	755	743	771	759	778	766	790	777	7605
30XQ1090 Module A	2231	2157	7164	1942	1942	892	1496	739	727	755	743	771	759	778	766	790	777	7605
30XQ1160 Module A	2231	2157	7164	1942	1942	892	1496	739	727	755	743	771	759	778	766	790	777	7605
30XQ1320 Module A/B	2231	2157	7164	1942	1942	892	1496	739	727	755	743	771	759	778	766	790	777	7605
30XQ1410 Module B	2231	2157	7164	1942	1942	892	1496	739	727	755	743	771	759	778	766	790	777	7605
30XQ0750	2231	2157	8358	1942	1942	892	2690	1003	1009	949	955	895	901	870	876	796	800	9054
30XQ1250 Module A	2231	2157	8358	1942	1942	892	2690	1003	1009	949	955	895	901	870	876	796	800	9054
30XQ1410 Module A	2231	2157	8358	1942	1942	892	2690	1003	1009	949	955	895	901	870	876	796	800	9054
30XQ1500 Module A/B	2231	2157	8358	1942	1942	892	2690	1003	1009	949	955	895	901	870	876	796	800	9054

Note: (1) foot screw even hole number (far side) represent for evaporator side  
 (2) foot screw, M20X300



## Evaporator Water Pressure Drop, 30XA0252~1502

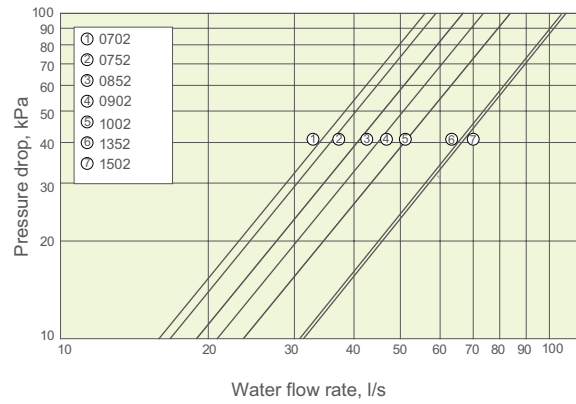
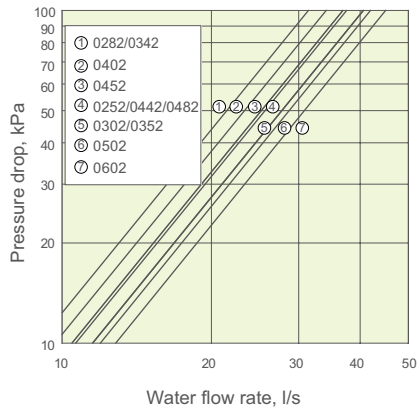

## Evaporator Water Pressure Drop, 30XA0652~1392

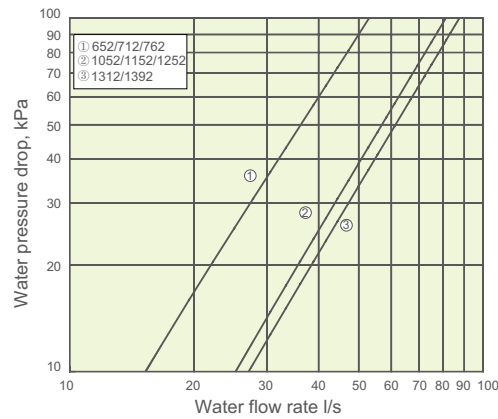

## Heat exchanger Water Pressure Drop, 30XQ0330~1500

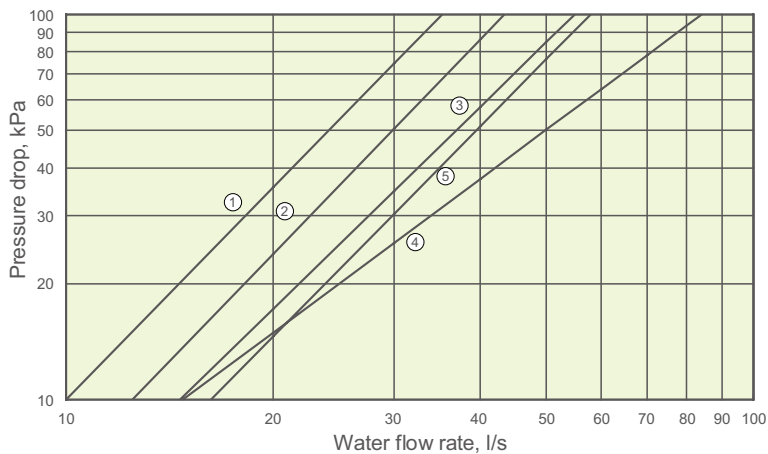

1. 30XQ0330
2. 30XQ0430, 30XQ0860 ModuleA/B, 30XQ0930 ModuleB, 30XQ1090 ModuleB
3. 30XQ0500, 30XQ0930 ModuleA, 30XQ1000 ModuleA/B, 30XQ1160 ModuleB, 30XQ1250 ModuleB
4. 30XQ0660, 30XQ1090 ModuleA, 30XQ1160 ModuleA, 30XQ1320 ModuleA/B, 30XQ1410 ModuleB
5. 30XQ0750, 30XQ1250 ModuleA, 30XQ1410 ModuleA, 30XQ1500 ModuleA/B

## Hydronic Connections, 30XA

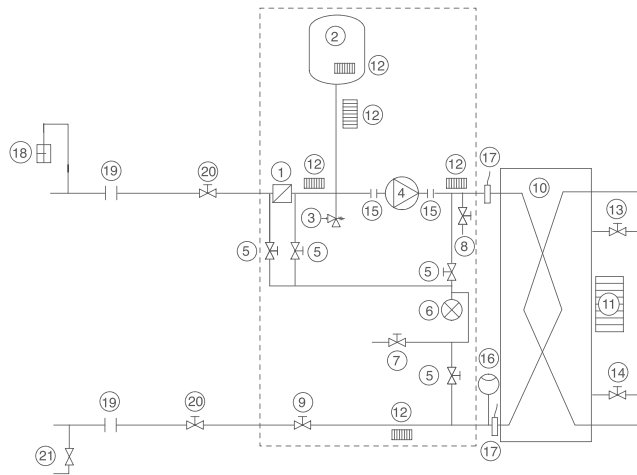

### Legend:

#### Components of the unit and hydronic module

- 1 Victaulic screen filter
- 2 Expansion tank
- 3 Safety valve
- 4 Water pump
- 5 Pressure tap valve (see Installation Manual)
- 6 Pressure gauge to measure the component pressure loss (see Installation Manual)
- 7 System vent valve
- 8 Drain valve
- 9 Water flow control valve
- 10 Evaporator
- 11 Evaporator anti-freeze heater (option)
- 12 Hydronic module anti-freeze heater (option)
- 13 Air vent (evaporator)
- 14 Water purge (evaporator)
- 15 Expansion compensator (flexible connections)
- 16 Flow switch
- 17 Water temperature sensor

#### System components

- 18 Air vent
- 19 Flexible connection
- 20 Shut-down valves
- 21 Charge valve

--- Hydronic module (option)

## Available Static System Pressure

High-pressure pumps

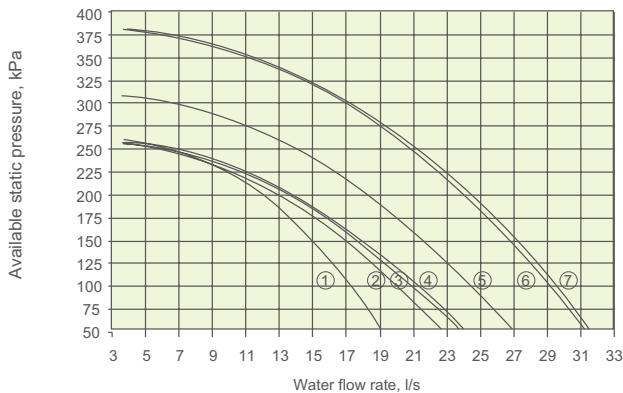

### Legend

- 1 30XA 0252/0282
- 2 30XA 0342
- 3 30XA 0352
- 4 30XA 0302
- 5 30XA 0402/0442
- 6 30XA 0452/0482
- 7 30XA 0502

## Minimum Water Loop Volume

For better control of leaving water temperature, the water loop minimum capacity is given by the formula:

$$\text{Capacity} = \text{CAP (kW)} \times \text{N Liters}$$

Application		N
Normal air conditioning	30XA0282-0482/30XA0252-1502/30XA0652-1392	3.5
	30XQ0330-1500	3.5
Process cooling	30XA0282-0482/30XA0252-1502/30XA0652-1392	6.5
	30XQ0330-1500	6.5

Where Cap is the nominal system cooling capacity (kW) at the nominal operating conditions of the installation.

This volume is necessary for stable operation and accurate temperature control.

It is often necessary to add a buffer water tank to the circuit in order to achieve the required volume. The tank must be internally baffled in order to ensure proper mixing of the liquid (water or brine). Refer to the examples below.

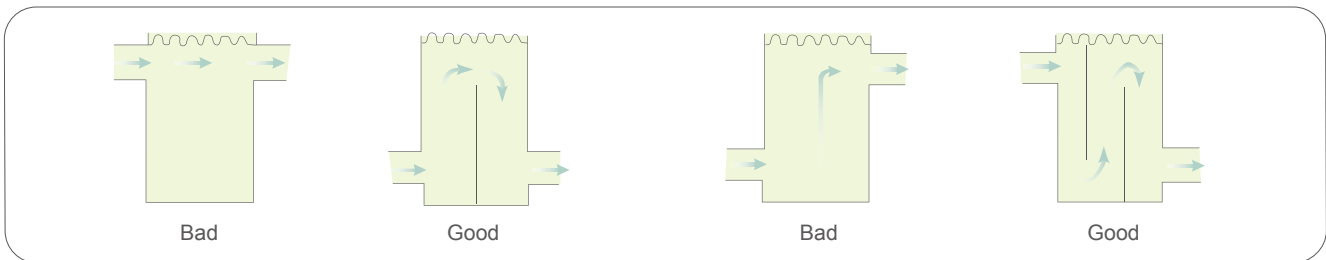

## Field Control Wiring, 30XA/30XQ

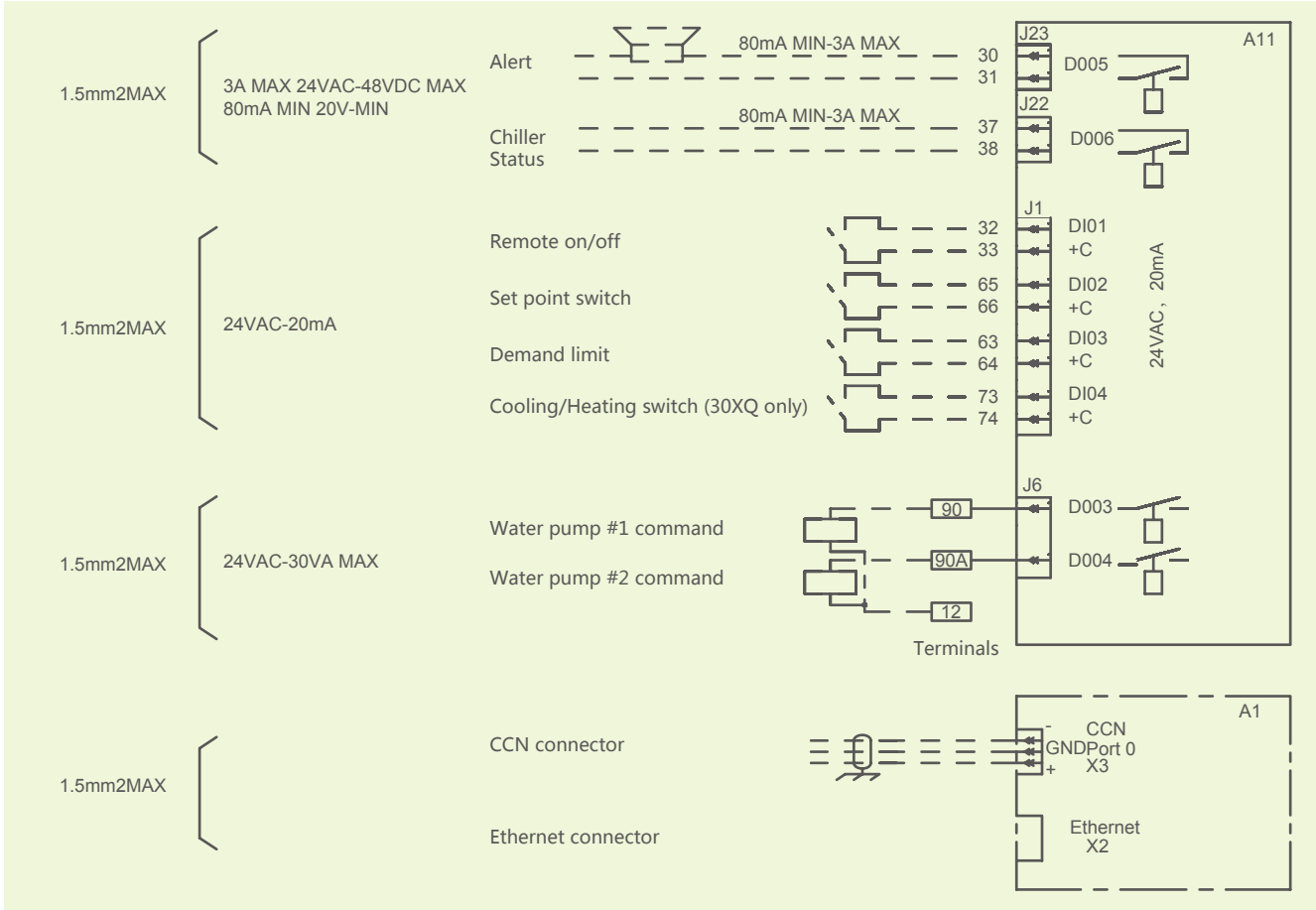



Carrier improves the world around us; Carrier improves people's lives; our products and services improve building performance; our culture of improvement will not allow us to rest when it comes to the environment.



[www.carrier.com](http://www.carrier.com)

The Manufacturer reserves the right to change any product specifications without prior notices  
© All Rights Reserved Carrier

Version:	CAT_30XAXQ_E-1508_04
Supercede:	CAT_30XAXQ_E-1412_03
Effective date:	Aug. 2015